

PRODUCT CATALOG 2020



Why choose TreCe?

We are one of the leading Nordic suppliers of storage furniture. We have reached this position by developing continuously. With over forty years of experience we have together with our customers managed to collect a lot of knowledge, and through the years we have learned what works. Our long experience together with a strong innovation drive drives us forward and creates the conditions for continuously developing new storage and recycling solutions.

Sustainability and Design

We manufacture our products in Sweden. It's a choice we made for several reasons. One of the reasons is that we want full control over how our products are produced, and that our high demands on the environment, quality and social responsibility are met. During manufacture, we use design solutions and materials with minimal environmental impact. Most of our products are environmentally certified according to Möbelfakta.

Another reason is that we can adapt the furniture to our customers' wishes, or customize individual products to meet the specific needs of our customers.

We work with design as a method for developing new solutions and products. In our development work we look at design from a further perspective that includes both aesthetics and sustainability as function and usability.

Working together

Our customers' opinions are important to us because they give us valuable insights into which products we need to develop to meet the market demand. When we start a project we listen and investigate what needs exist and develop a plan to solve them together. By working together, we can make sure that our customers' thoughts and ideas are included from the first call to the completed project.

Storage experts

We are pleased to share our knowledge with our customers, whether it's flexibility and functionality in the modern office or smart solutions for tomorrow's activity based offices. With our combined experience and knowledge, we create an optimal solution.

Please contact us for a presentation, to learn more about how we can create a working solution together.



Space

Design | TreCe

Doors with seamless fronts in MDF as standard, choose your preferred NCS color after taste and preferences. The frames are also available in any NCS color. Choose between different frame and door heights.

Doors are available with cabinet locks (incl. 2 keys), padlock fittings (excluding padlock) or RFID locks. Doors are also available with mail-inlets. As accessories, there are movable shelves, clothes rail, mirror, hooks, carpets and the cork box Stuff.

Complete the look with cover panels and worktops, perfect for when placed back to back. See modules and other accessories on pages 48 to 54.

More info →





Office

Design | TreCe

Office is a product family designed to meet the needs of the modern office. Smart solutions that focus on function and with a low environmental impact. Made from needled blanket with 7% wool, 93% polyester, and with details in untreated leather.

Office Backpack, an office bag and backpack for those who want a bag that works both around and outside the office. Organize, store and move your office supplies and laptop with Office Backpack.

Office Bag, a practical and functional office bag for the activity-based office. Several compartments for storing a laptop, binders and other things that you want available. Practical shoulder strap.

Office Sleeve, laptop case suitable for most laptop computers.

Office Pouch, a practical small bag for cables, keys, USB-sticks etc.

More info →



Office Backpack

Office Bag

Office Pouch

Office Sleeve

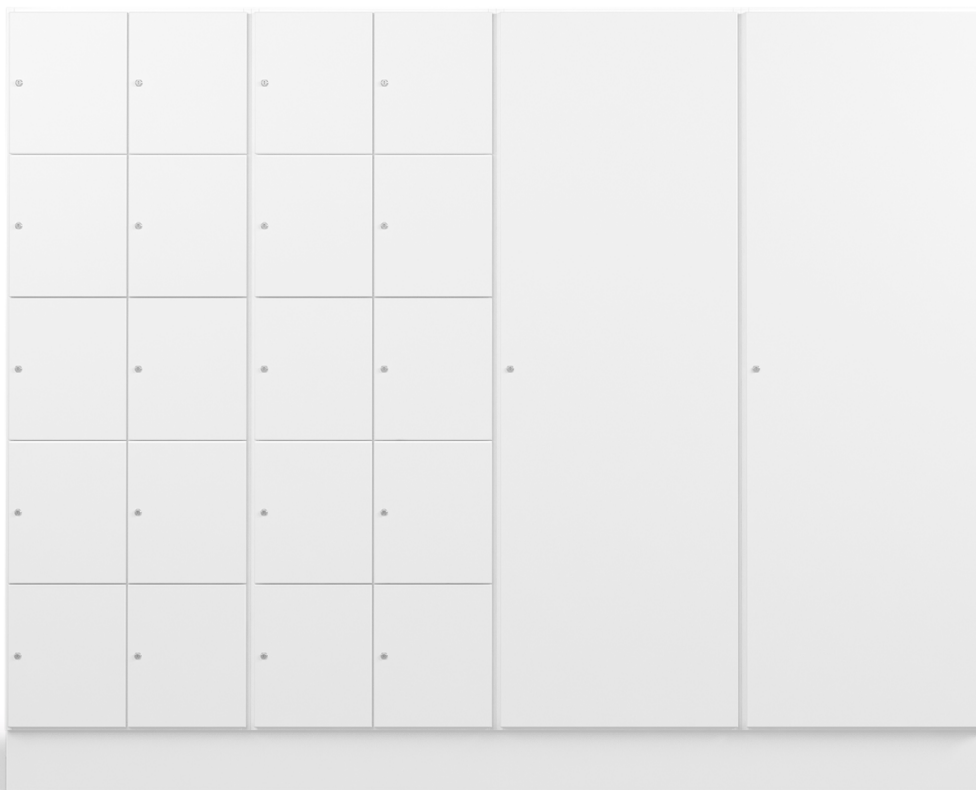

CombiLine

Lockers

Design | TreCe

Lockers for personal or public storage. Cabinet locks included as standard with 2 keys. The locks are adapted to a master key system and the lockers can be fitted with mail inlets and mail shelves.

The storage compartments are highly customizable and fit most areas. Standard widths: 310 mm, 605 mm and 900 mm.

More info →



CombiLine

Wardrobe

Design | **TreCe**

Space efficient lockable wardrobes designed to blend into the work environment. Clothes rail and hat rack always included as standard. Master key to all locks can be ordered separately.

[More info →](#)



Fjäll

Design | **Elisabeth Ulander**

Fjäll is a stylish storage piece that can be placed on both small and large surfaces through its modular composition. Fjäll has a stable and minimalist design, inspired by Scandinavia. Fjäll is based on a basic module with a straight, or diagonal long side.

Fjäll is a concept that is based on honest, solid and environmentally friendly materials. All the frames and fronts are in the basic version painted MDF. Fjäll is a high quality piece of furniture where the greatest possible weight has been placed on a combination of aesthetics, function and smart storage, all the time with the user in focus.

More info →



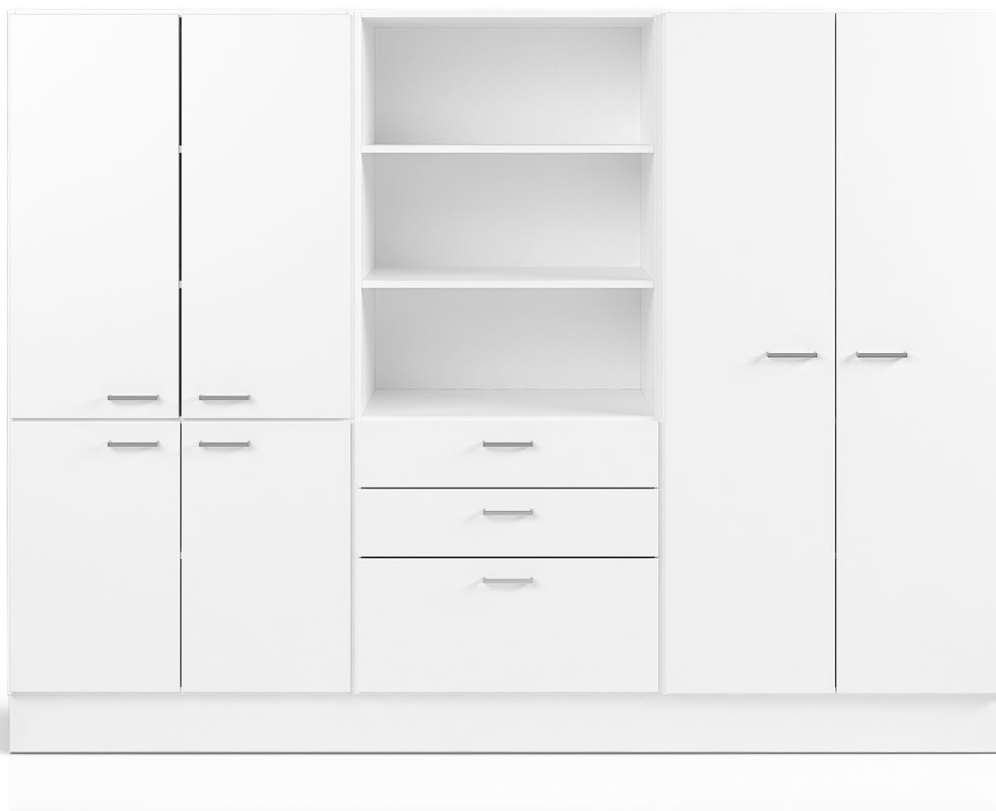

CombiLine

Office shelf

Design | TreCe

Shelves and cupboards for storage of large volumes. Can be ordered in different widths, heights and depth. Possibility to choose glass doors, glass shelves, drawers or filing drawers.

Worktops for the lower models are also available as a supplement.

More info →

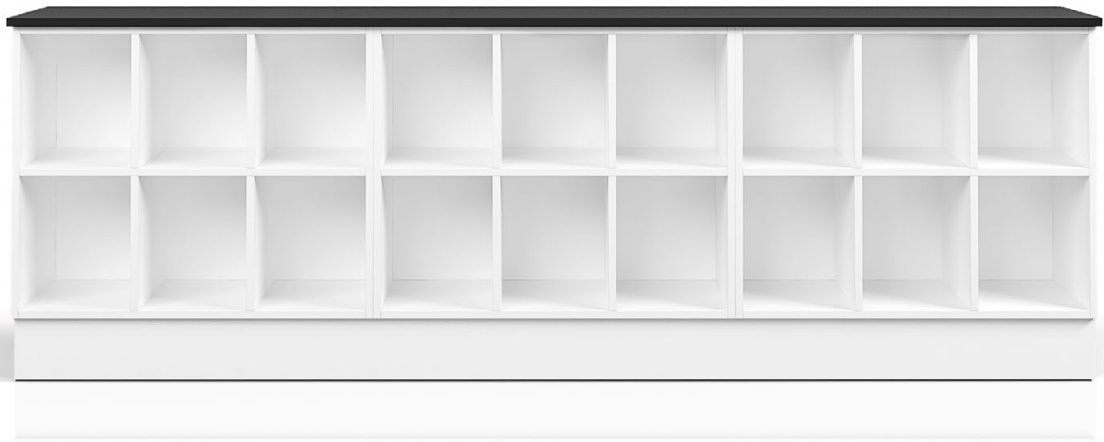

CombiLine

Combi shelf

Design | **TreCe**

Our most adaptable storage furniture. Build from floor to ceiling. Standard widths: 310 mm, 605 mm and 900 mm. Take advantage of wall surfaces with a wall mounted Combi shelf and create a unique module by combining accessories.

Worktops for the lower models are also available as a supplement.

More info →



CombiLine

Magazine shelf Expo

Design | **TreCe**

Display area in black or white powder-coated steel for showing newspapers, books or reference materials.

Plenty of storage space behind the display areas. Mounting strip is included with all wall modules.

More info →



CombiLine

Wall cabinet/shelf

Design | **TreCe**

Wall-mounted shelves and cabinets serve as space saving alternatives or complements to our floor standing modules.

More info →



CombiLine

Cabinet

Design | **TreCe**

Space efficient cabinets that utilize all the office space.
Stainless steel handles included as standard.

Create your own combination. Choose between different modules, open, with doors or with drawers. Available in two different standard heights 880 and 1057 mm.

More info →



CombiLine

Printer cabinet

Design | TreCe

Printer cabinet in an ergonomic height which can easily be combined with other storage furniture. Standard height: 704 mm.

Create your own combination. Choose between different modules, open, with doors or with drawers. Stainless steel handles included as standard.

More info →



CombiLine

Work station

Design | TreCe

Flexible piece of furniture with great varieties and storage from both sides where one side has drawers that can withstand up to a 50 kg load with full extension and soft closing. Standing on a white powder coated sturdy steel frame, height 300 mm. Frame and fronts in white. Stainless steel handles as standard, worktops in white or anthracite. If you would like black or white handles, please note this on your order.

More info →

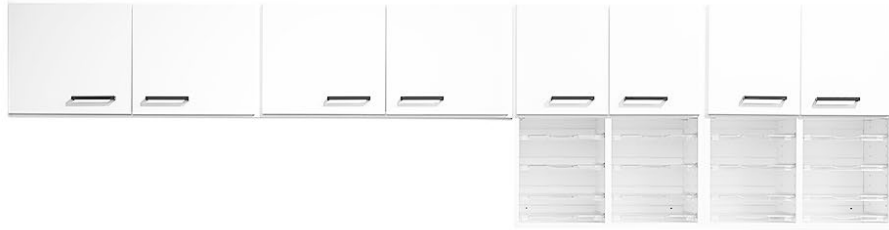

CombiLine

Copy station

Design | TreCe

Ready combined stations consisting of wall cupboards, mail shelves and cabinets.

Frames and fronts in white, worktops in anthracite. Stainless steel handles as standard. You can also get the handles in black or white. All low drawers can hold up to 30 kg. Drawers that can hold up to 50 kg are available upon request.

More info →

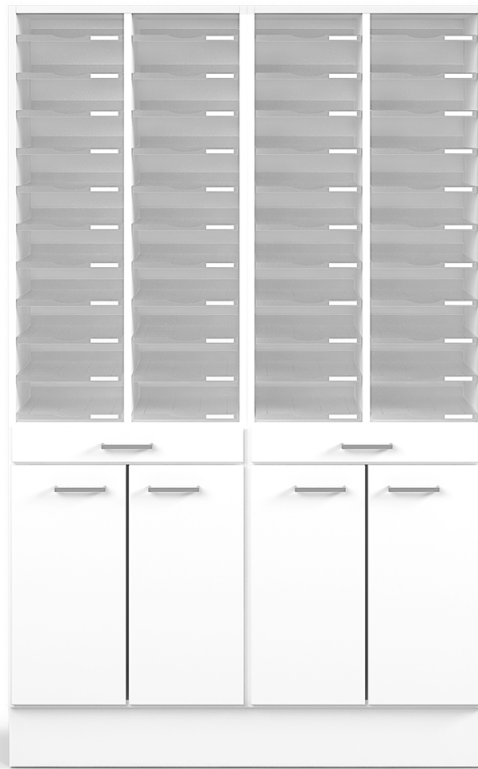

CombiLine

Mail sorting

Design | TreCe

Complete module series for mail sorting. Adaptable according to need and taste – the height or width of the floor or wall with any number of mail shelves.

Mail slots with reach-through capability makes it possible to manage mail from both sides. Mail sorting can be supplemented with more mail shelves.

More info →



Mail

Design | TreCe

Space efficient piece for the new era of post sorting. Mail is available in white and can accommodate hanging folders in folio format, has a mail slot for out-going mail, a waste unit and a drawer for office supplies. Custom designed symbols and a 60-liter container are included.

More info →



Place

Design | **Studio Doms**

Open shelves for room division and storage. Made of dark gray powder-coated aluminum with decor shelf in light ash and brass details. Place is a shelf system with great combination possibilities that can easily be tailored to your specific needs. Place is available in two widths (361 and 739 mm, excl. end gables) and three different heights (1003, 1433 and 1863 mm) that can be easily assembled and adapted as needed.

As a step in TreCe's continuous environmental work, Place is delivered in flat packages and can be mounted easily on site.

More info →

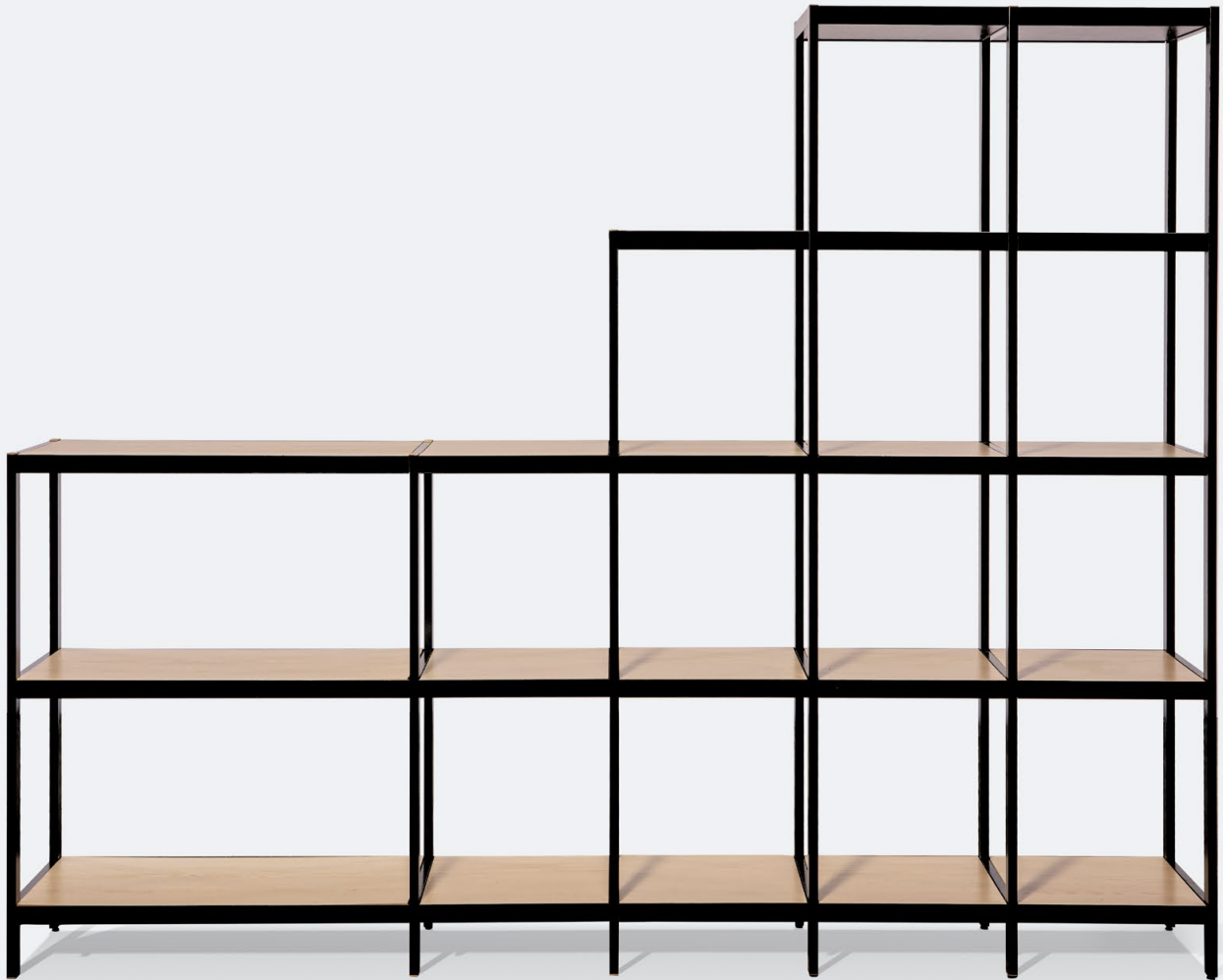



Soft

Design | **Studio Doms**

Storage unit in white pigmented ash veneer or white lacquered MDF. Both models have the same high quality on all sides and comes with robust legs in white pigmented solid ash.

Made of carefully selected materials with low environmental impact where all the wood is traceable.

Available in versions of two, three and four storage units. All units are prepared for media storage, with outlets for cables and ventilation. Soft is also available as a wall module.

More info →



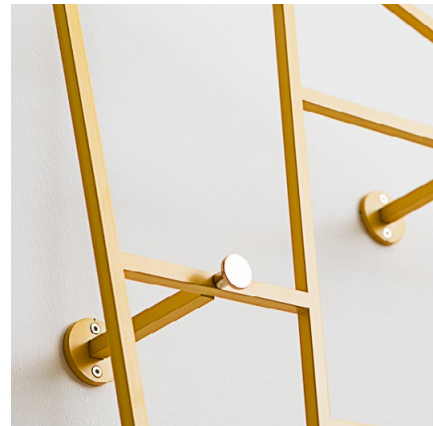

Sail

Design | Studio Doms

Clothes hanger for several types of hanging traditionally on the knobs, hanging over the rods or with a coat hanger.

Sail is available as floor standing or as a wall mounted module, with matching wall mounts.

Sail Floor comes in two parts, Sail wall is delivered as one unit with matching wall mounts. Both are delivered in a flat package and are easy to assemble.

- Laser cut-out from one whole piece
- No welding joints
- Powder-coated steel
- 11 selected RAL colors
- Accented knobs in brass

More info →

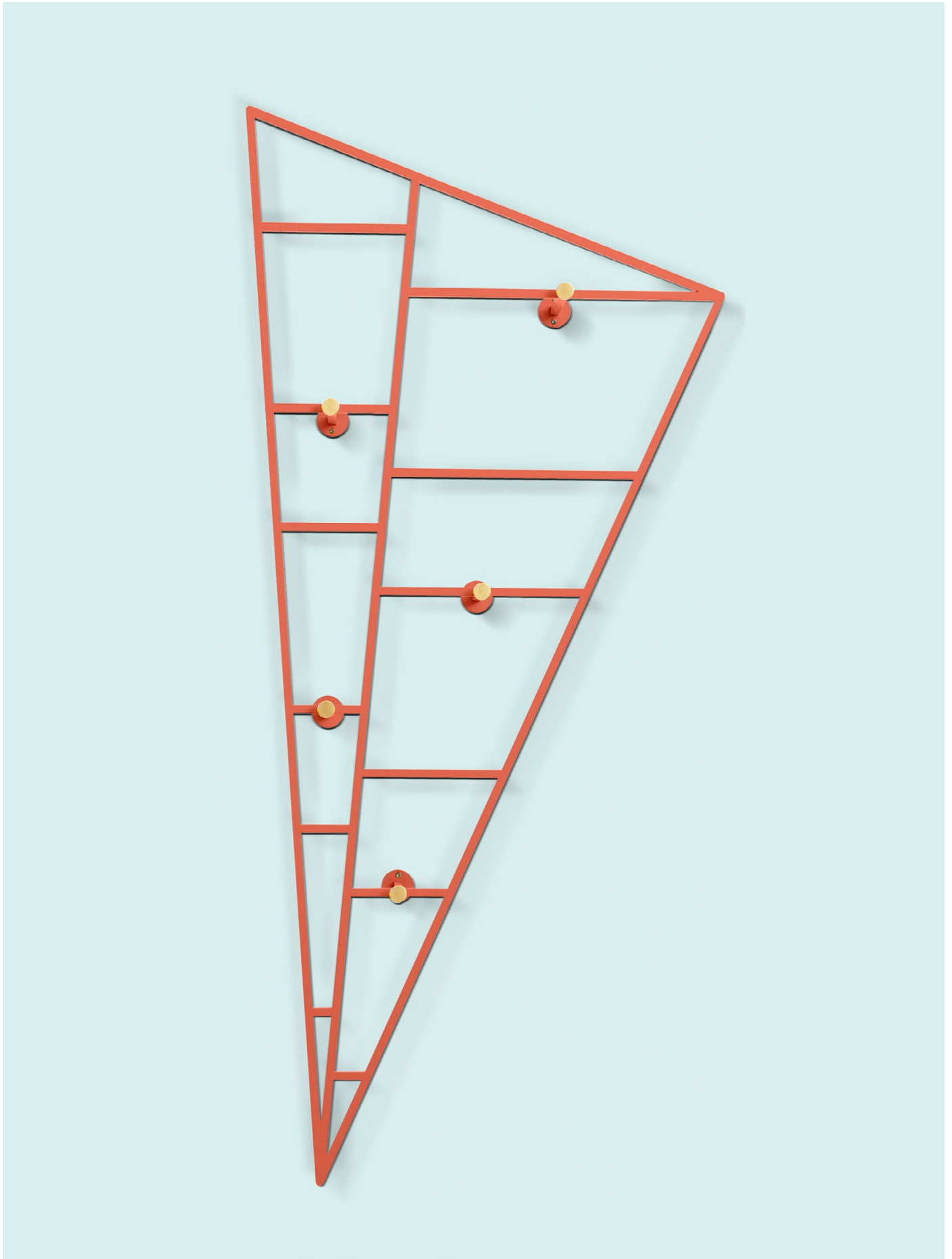



Birdie

Design | **Studio Doms**

Flexible recycling piece made of resistant Swedish steel. Available in 11 standard colors and delivered with specially designed symbols for easy sorting. Birdie is made in two sizes and holds 43 L (Birdie 500) and 63 L (Birdie 750). Both have soft closing lids and inlets in stable quality plastic.

Birdie has received many international awards thanks to its unique shape and good design.

[More info →](#)

2016
**EUROPEAN
PRODUCT
DESIGN
AWARD™**





Cloud

Design | **Ebba Hellberg & Sigrid Ljungström**

Cloud is a mobile recycling unit designed to fit into a modern work environment where flexibility and aesthetics are two key factors. A simple and classy design with the characteristic rounded corners and the bold wheels that invite you to move Cloud around. With inlets from both sides, Cloud can be placed against a wall or in the middle of a room.

Cloud's frame is available in both laminate and lacquered MDF. Doors and backs in powder-coated steel.

More info →



**GERMAN
DESIGN
AWARD
WINNER
2019**





Kite

Design | **Annica Doms**

A modulated recycling unit designed by Annica Doms. Awarded the Red Dot Design Award for its innovative form. Designed for modularity in different configurations. Kite can be placed against the wall or as a free-standing accent in the room.

The many possible combinations challenges the imagination and inspires creativity. Lids with eight different designs with varying shapes and screen printed symbols for different types of waste.

Kite is available in 11 RAL colors and Kite Raw with lids in two standard colors and Kite Raw. Kite holds 70 liters, designed for standard bag of 85–125 liters.

More info →



reddot design award
winner 2012



GERMAN
DESIGN
AWARD
WINNER
2020





Kite mini

Design | **Annica Doms**



Kite, has retrieved both its name and its appearance from the geometric shape of a kite.

The straight angles give a bold and exciting expression, and at the same time harmonize with the room and its shape. The unique form holds angles of 60 °, 90 ° and 120 ° which makes it ideal to place in corners with varying angles. Kite mini has on the same shape and is an exact copy of Kite, but in a reduced size. This gives a clear "family feeling" and a uniform expression.

Kite mini is intended for smaller spaces like under desks, hotel rooms or smaller conference rooms. There is also a wall mount for Kite mini, which means that it can be placed on the wall. As single or in pairs to free floor space. Kite mini is available in 11 RAL colors with lids in two standard colors.

More info →

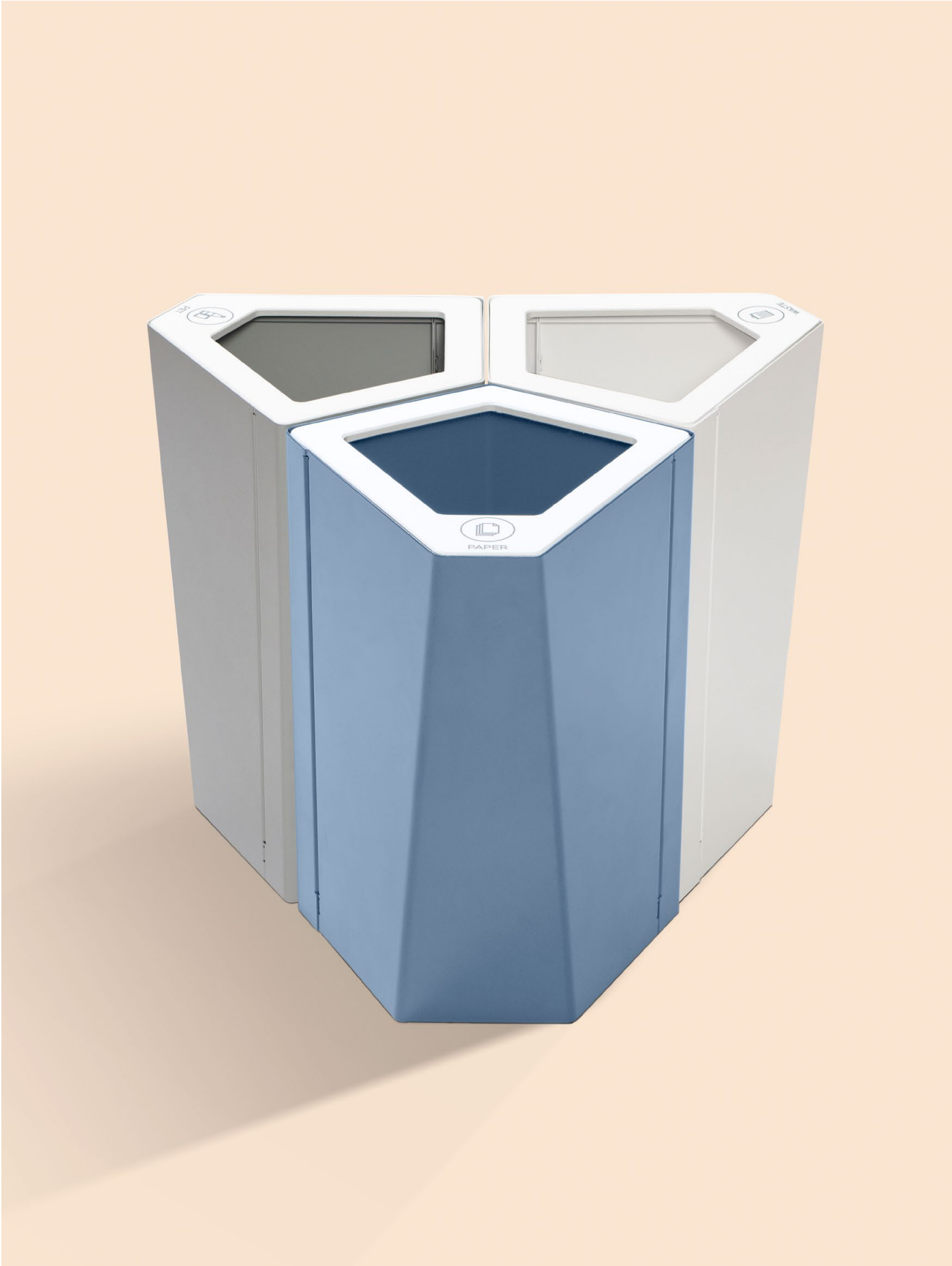



Hold

Design | **Tengbom**



TreCe, together with Tengbom architects, have developed the recycling bin Hold.

A collaboration that started with Tengbom seeing a need for a different and functional recycling bin that could meet the needs of smaller spaces. Conference rooms, hotel rooms, smaller meeting rooms, etc. TreCe was contacted and the result was Hold.

A small and functional bin with a lid that is available in 7 different profiles. There is also a wall mount for Hold, which means that it can be placed on the wall. Hold is available in 11 RAL colors.

More info →





Ridge

Design | **Studio Doms**

Ridge, with its special expression, becomes a different and expressive feature in the modern office. It gives the impression of an interior detail, not just a recycling station. Standing together Ridge creates a feeling of a city skyline. Details such as bevelled outer edges and a slight distance between the frame and top shows a feel of quality and detail.

A very stable construction that is built of 22 mm MDF and lacquered in 11 standard colors. The stainless steel ramp for easy access of a 140 liter waste bin is not only a practical detail, but also a part of the design that stands out. Ridge is also available in two heights, low and high. What distinguishes low and high is the slope of the upper frame.

Both versions are easily emptied with the door's aximate hinges, 135° opening. Ridge can be ordered with different recycling symbols depending on the purpose and waste.

More info →





CombiLine

Recycling station

Design | TreCe

Ready combined recycling stations that cover the entire waste sorting for both large and small offices. Stainless steel handles are standard.

There are four ready combined recycling stations. Recycling station 2 is shown in the picture above.

If you would rather combine your own station, see Recycling units on page 95.

More info →



Drawing cabinet

Design | TreCe

White laminated frame with white lacquered fronts with stainless steel handles. Drawers have rails with integrated hubs that make them easy to handle which makes the storage more functional and versatile.

More info →



Archive shelf

Pine

Design | **TreCe**

Archive shelf in massive lacquered pine.
Stable construction that is easy to move and adjust.

Archive shelf pine is available as a complete start section
which then can be supplemented with add-on sections.
Max load 100 kg / shelf.

More info →



Archive

Steel/Pine

Robust, flexible archive for efficient storage of large quantities. Gables and shelves in steel can hold high loads, 50-120 kg per shelf at distributed load. It's also possible to customize the archive so it can hold even more weight. Choose between steering wheel, power steering or handle.

Lacquered sheet steel as shown above or with side panels and shelves in solid varnished pine.

Can be adapted to different archive formats, for example landscape A4 or portrait A4. The height, width or length of the system can be easily adjusted as required.

More info →



Wall-mounted storage

Design | TreCe

Build your own wall-mounted storage from shelves, rails and brackets.

Maximum length of shelves without joints is 2400 mm. Remember to include mounting brackets when dividing a shelf.

More info →

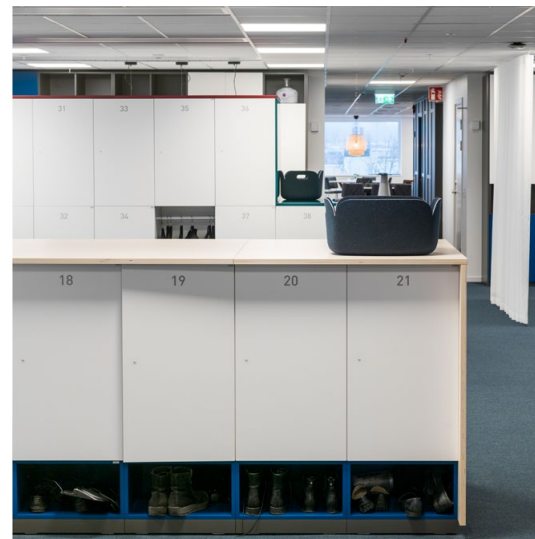
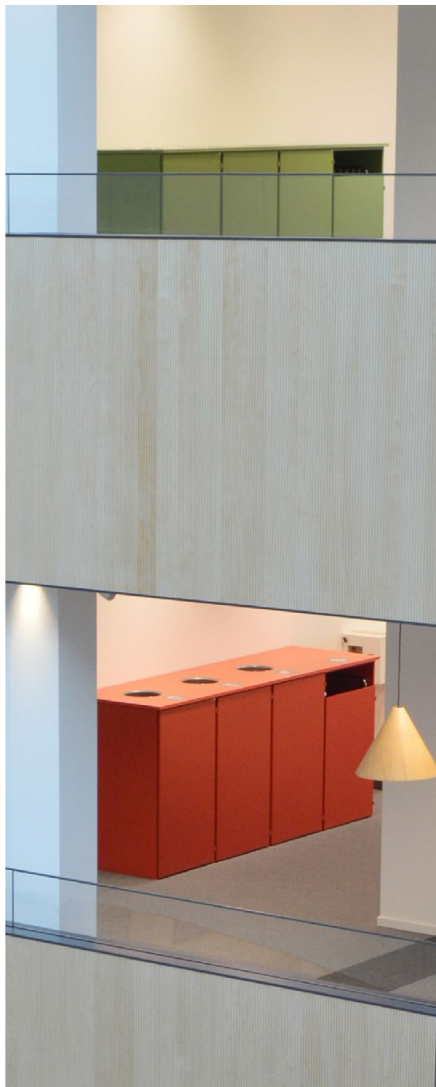

Dimensions: Width x Height (incl. plinth). x Depth. **Frame and front:** 16 mm. **Plinth:** 143 mm.
All doors are right-hung as standard.

Space

Storage

Doors with seamless fronts in MDF as standard, choose your preferred NCS color after taste and preferences. The frames are also available in any NCS color. Choose between three frame heights and four door heights.

Doors are available with cabinet locks (incl. 2 keys), padlock fittings (excluding padlock) or RFID locks. Doors are also available with mail-inlets. As accessories, there are movable shelves, clothes rail, mirror, hooks, carpets and the cork box Stuff.

Complete the look with cover panels and worktops, perfect for modules placed back to back.

Specifications →



Inside of locker door with mail-inlet and movable shelf.

Finished modules – model double incl. cabinet locks

Inside dimensions/locker: Space door/locker low 363x424x454 mm. **Inside dimensions/locker:** Space door/locker high 363x864x454 mm.
Cabinet locks included in the finished modules, incl. 2 keys. **Frame, plinth and divider** in white MFC laminate, 16 mm with 0,8 mm straight ABS-lipping.
Fronts in 16 mm MDF, NCS S 0500-N, white.

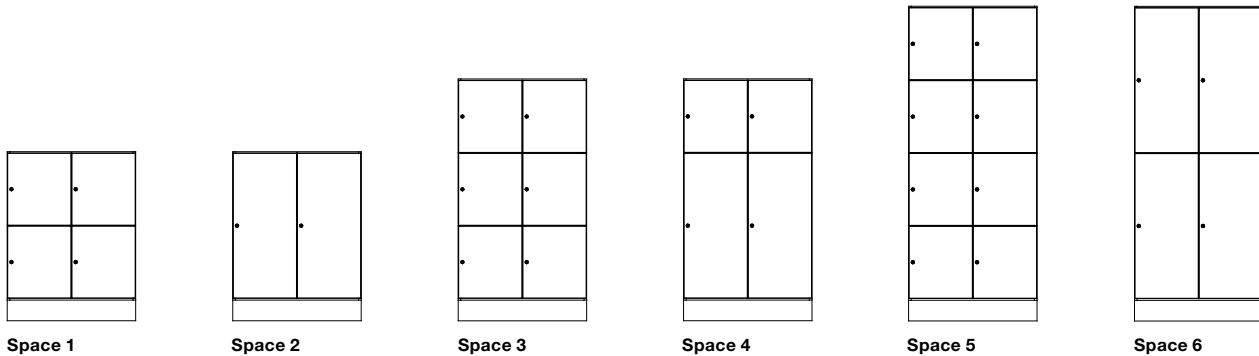

Name, finished modules	Size	White
Space 1 double low, 4 door low	790x1039x470	208111
Space 2 double low, 2 door high	790x1039x470	208112
Space 3 double middle, 6 door low	790x1487x470	208113
Space 4 double middle, 2 door low + 2 door high	790x1487x470	208114
Space 5 double high, 8 door low	790x1936x470	208115
Space 6 double high, 4 door high	790x1936x470	208116

Dimensions: Width x Height (incl. plinth), x Depth. **Frame and front:** 16 mm. **Plinth:** 143 mm.
All doors are right-hung as standard.

Tips!

Combine several finished modules. Example of a combination: **Space 3+4+3+3+6 + Space wardrobe with double doors.** All modules can also be lacquered in any NCS.

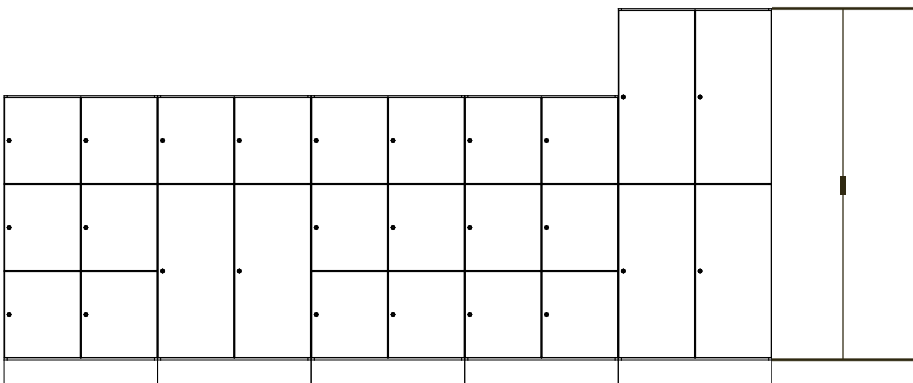

Finished modules – model single incl. cabinet lock

Inside dimensions/locker: Space door/locker low 363x424x454 mm. **Inside dimensions/locker:** Space door/locker high 363x864x454 mm. **Cabinet locks** included in the finished modules, incl. 2 keys. **Frame, plinth, back and divider** in white MFC laminate, 16 mm with 0,8 mm straight ABS-lipping. **Fronts** in 16 mm MDF, NCS S 0500-N, white.

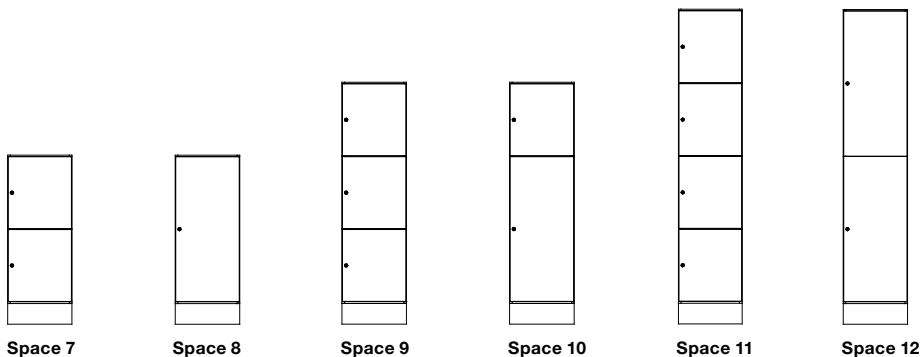

Name, finished modules

Name, finished modules	Size	White
Space 7 single low, 2 door low	395x1039x470	208117
Space 8 single low, 1 door high	395x1039x470	208118
Space 9 single middle, 3 door low	395x1487x470	208119
Space 10 single middle, 1 door low+1 door high	395x1487x470	208120
Space 11 single high, 4 door low	395x1936x470	208121
Space 12 single high, 2 door high	395x1936x470	208122

ABOUT SPACE:

MFC laminated surfaces within Space have a chip core, with the exception of some shelves. Back, frame and edging strip have matching colors unless otherwise stated.

Fronts, Shoe shelf, Open shelf/Bench and Storage box open/Flower box have an MDF core. Textiles at an additional cost.

Frame incl. plinth: Thickness 16 mm, with 0,8 mm straight ABS-lipping.

- MFC laminate, white.
- Lacquered, any NCS-color.

Back: Thickness 12 mm, MFC laminate in- and out. Lacquered when choosing any NCS-color.

Plinth: Each unit has its own setback plinth, front and rear, with 4 adjustable feet, (Plinth 143 mm.)

Front: Seamless fronts, thickness 16 mm Lacquered MDF, any NCS color.

Drawers: Drawers are soft-closing. Extension capacity of 100%, maximum weight 35 kg. Drawers with railings or with elevated sides.

Seat module with hatch door: Opens downwards with gas spring. Milled-in handle.

Shoe shelf, Open shelf/Bench and Storage box open/Flower box

Thickness 16 mm. Lacquered MDF, any NCS color. Modules aligned with fronts.

Double doors Wardrobes: With milled-in handles.

Mail inlet: Powder-coated steel, White (RAL 9010). Opening 290*20 mm. Mail inlet has an angled steel lip on the inside of the door.

Hinges:

Self closing concealed hinges with integrated soft closing. Doors are right-hung as standard.

Shelves, fixed: Shelves mounted with milled-in connection fittings that are secured with screws. Shelves for lockers have a chip core. Shelves for wardrobes have a lamellar wood core.

Shelves, movable: Shelves are short-end in the front. Mounted with connection fittings, adjustable by drill division of c/c 32 mm.

Cover panels/Top cover panels: Thickness 16 mm. Lacquered MDF, any NCS color.

Top cover, socket strip: Thickness 28 mm. Lacquered MDF, any NCS color.

Accessories: Clothes rail, carpet, clothes hook, anchor hook, mirror and cork box Stuff.

Lock types: Cabinets locks, padlock fittings, code locks, RFID-locks (EM & Mifare) and push-to-open.

Dimensions: Width x Height (incl. plinth). x Depth. **Frame and front:** 16 mm. **Plinth:** 143 mm.

All doors are right-hung as standard.

NCS refers to product lacquered in one optional NCS color.

Frames

Name	Size	White	NCS
Space Frame single low	395x1039x470	201108	201118
Space Frame single middle	395x1487x470	201109	201119
Space Frame single high	395x1936x470	201110	201120
Space Frame double low	790x1039x470	201111	201121
Space Frame double middle	790x1487x470	201112	201122
Space Frame double high	790x1936x470	201113	201123
Space Frame wardrobe	790x1936x470	204110	204120

Incl. plinth, excluding fixed and movable shelves. Double incl. divider.

White: MFC laminate. **NCS:** Lacquer any NCS. Clothes rail included in Space frame wardrobe, double doors ordered separately.

Shelves

Name	Size	White	NCS
Space shelf single fixed	363x16x451	205009	205019
Space shelf single movable*	363x16x385	205010	205020
Space shelf double fixed	371x16x451	205011	205021
Space shelf double movable*	371x16x385	205012	205022
Space shelf wardrobe, fixed	755x19x451	205031	205041

*Indrawn front.

White: MFC laminate. **NCS:** Lacquer any NCS.

Drawer/Hatch*

Name	Size	NCS
Space drawer, 100% expansion, 35 kg, RFID** (with high sides)	392*446*450	208060
Space drawer, 100% expansion, 35 kg, RFID** (with low sides)	392*446*450	208061
Space hatch door wardrobe, opens downwards (milled-in handles, Gas springs)	788*296*16	204071

*Aligned with fronts. **RFID locks will be added separately.

NCS: Lacquered MDF, any NCS.

Shoe shelf*

Name	Size	NCS
Space open shoe shelf, single	395x232x487	207092
Space open shoe shelf, double	790x232x487	207091

*Aligned with fronts.

NCS: Lacquered MDF, any NCS.
Carpet, see accessories page 54.

Storage box open/Flower box*

Name	Size	NCS
Space storage box open single, back to back	395x232x976	209092
Space storage box open double	790x232x487	209091

*Aligned with fronts. The unit is not water resistant.

NCS: Lacquered MDF, any NCS.
Carpets, see accessories page 54.

Contact TreCe if you want numbering on doors.

Doors

Name	Size	NCS
Space door low, cabinet lock	393x446	202121
Space door low, RFID**	393x446	202122
Space door low, lock+mail	393x446	202123
Space door low, padlock fitting**	393x446	202124
Space door low, RFID+mail**	393x446	202125
Space door low, push-out	393x446	202126
Space door high, cabinet lock	393x894	203121
Space door high, RFID**	393x894	203122
Space door high, lock+mail	393x894	203123
Space door high, padlock fitting**	393x894	203124
Space door high, RFID+mail**	393x894	203125
Space door high, push-out	393x894	203126

**Padlocks and RFID locks are ordered separately

Detail images of locks see page 54.

NCS: Lacquered MDF, any NCS

Doors wardrobes

Name	Size	NCS
Space door wardrobe low, cabinet lock	393x1342	204061
Space door wardrobe low, RFID excl. lock**	393x1342	204062
Space door wardrobe low, cabinet lock +mail	393x1342	204063
Space door wardrobe low, padlock fitting**	393x1342	204064
Space door wardrobe low, RFID excl. lock +mail**	393x1342	204065
Space door wardrobe low, push-out	393x1342	204066
Space door wardrobe high, cabinet lock	393x1790	204051
Space door wardrobe high, RFID excl. lock**	393x1790	204052
Space door wardrobe high, padlock fitting**	393x1790	204054
Space door wardrobe high, push-out	393x1790	204056
Space double doors wardrobes, milled-in handles	786x1790	204140

**Padlocks and RFID locks are ordered separately

Detail images of locks see page 54.

NCS: Lacquered MDF, any NCS

Open shelf/bench*

Name	Size	NCS
Space open shelf/bench, single	395x298x487	208092
Space open shelf/bench, double	790x298x487	208091

Cushions and fabric are ordered separately, contact TreCe.

Space shelf movable, single	363x16x469	205052
Space shelf movable, double	758x16x469	205051

*Aligned with fronts..

NCS: Lacquered MDF, any NCS.

Seat height 441 mm, incl. plinth

Plinth

Name	Size	White	NCS
Space plinth, single	395x143x430	208072	208082
Space plinth, double	790x143x430	208071	208081

White: MFC laminate. **NCS:** Lacquer any NCS.

Dimensions: Width x Height (incl. plinth). x Depth. **Frame and front:** 16 mm. **Plinth:** 143 mm.

All doors are right-hung as standard.

NCS refers to product lacquered in one optional NCS color.

Cover panels

Name	Size	NCS
Space cover panel single, low	490x1046	206021
Space cover panel single, middle	490x1494	206022
Space cover panel single, high	490x1942	206023
Space cover panel double, low***	980x1046	206521
Space cover panel double, middle***	980x1494	206522
Space cover panel double, high***	980x1942	206523

*** When placing modules back to back.

NCS: Lacquered MDF, any NCS.
Thickness: 16 mm.

Top cover

Name	Size	NCS
Space top cover single panel	490	207021
Space top cover double panel***	980	207022

*** When placing modules back to back.

NCS: Lacquered MDF, any NCS.
Thickness: 16 mm.



790x1936x470 Seat height: 441 mm excl. cushion



790x1487x470 Interior dimensions: 363x1312x454



790x1271x470

Seat module with hatch door

Name	Art no
Space Frame wardrobe	204110
Space hatch door wardrobe, opens down	204071
Space shelf wardrobe, fixed	205031

Cushions and fabric are added, contact TreCe.

Personal wardrobe

Name	Art no
Space Frame wardrobe	201112
Space door wardrobe low, RFID excl. lock (x2)	204062
Space shelf double movable (x2)	205012
anchor hook (x2)	830899

RFID-locks are added, contact TreCe.

Personal locker + flower box

Name	Art no
Space 2 low, 2 door high	208112
Space storage box open double	209091

RFID-locks are added, contact TreCe.



790x1271x470



790x441x487 (excl. cushion)



2765x1055x470

Personal storage + shoe shelf

Name	Art no
Space 1 low, 4 door low	208111
Space open shoe shelf, double	207091

RFID-locks are added, contact TreCe.

Bench

Name	Art no
Space open shelf/bench, double	208091
Space shelf movable, double	205051
Space plinth, double	208071

Cushions and fabric are added, contact TreCe.

Personal lockers + top cover

Name	Art no
Space 1 low, 4 door low (x3)	208111
Space 7 single low, 2 door low (x1)	208117
Space top cover single	207021

RFID-locks are added, contact TreCe.

Dimensions: Width x Height (incl. plinth), x Depth. **Frame and front:** 16 mm. **Plinth:** 143 mm.
All doors are right-hung as standard.

Space Combinations

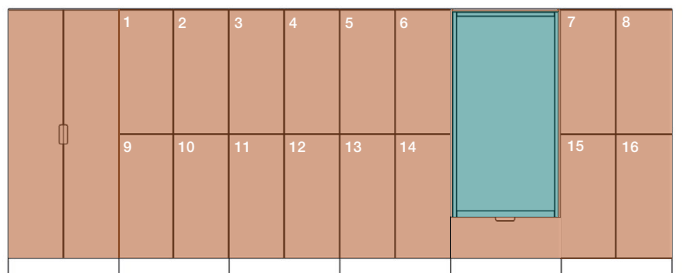
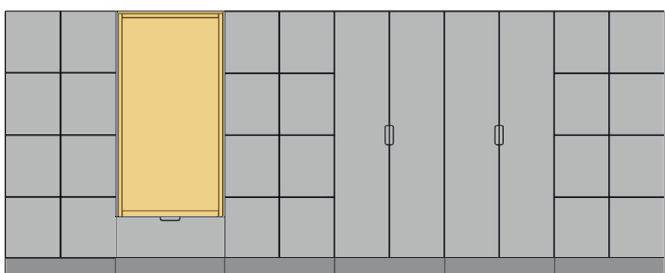
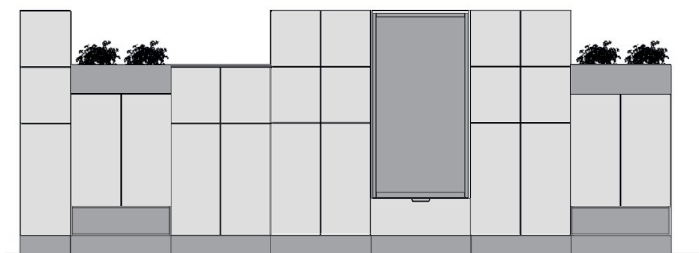
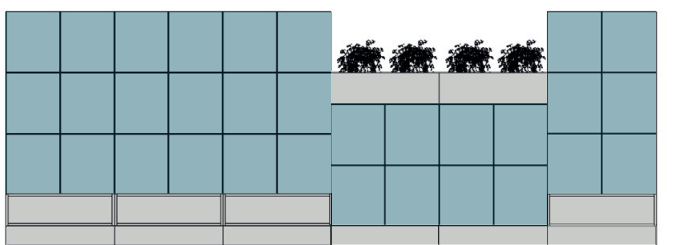
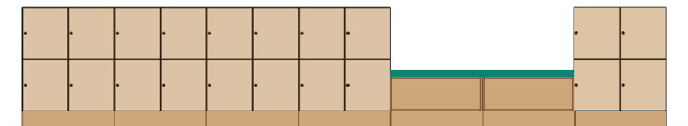
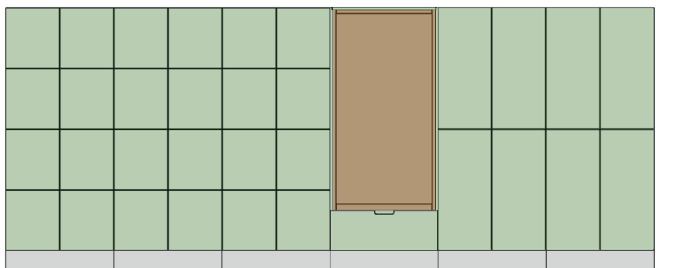

Dimensions: Width x Height (incl. plinth). x Depth. **Frame and front:** 16 mm. **Plinth:** 143 mm.

All doors are right-hung as standard.

NCS refers to product lacquered in one optional NCS color.

Space

Storage with power outlet

Personal storage with integrated electricity offers well-needed functionality in everyday life. Charge your mobile phone or computer securely in a locked compartment, ideal for the activity-based office, public places or schools.

Specifications →

Frames prepared for power strip fittings

Name	Size	White	NCS
Space Frame single middle, power	395x1487x470	205509	205519
Space Frame single high, power	395x1936x470	205510	205520
Space Frame double middle, power	790x1487x470	205512	205522
Space Frame double high, power	790x1936x470	205513	205523

Incl. plinth, excluding fixed and movable shelves. Double incl. divider.

White: MFC laminate. **NCS:** Lacquer any NCS.

Thickness: 16 mm.

Shelves

Name	Size	White	NCS
Space shelf single fixed, power	363x451	205109	205119
Space shelf single movable, power	363x385	205110	205120
Space shelf double fixed, power	371x451	205111	205121
Space shelf double movable, power	371x385	205112	205122

Thickness: 16 mm

White: MFC laminate. **NCS:** Lacquer any NCS.

Top cover

Name	Size	NCS
Space top cover single, power	490	207023
Space top cover double, power***	980	207024

***When placing modules back to back.

Thickness 28 mm, fits middle frames and conceals cabling.

NCS: Lacquered MDF any NCS.

Top cover, socket strip:

Name	Size	NCS
Space cover strip single, power	72	208032
Space cover strip double, power***	144	208034

***When placing modules back to back.

Cover strip, fits high frames, thickness 28 mm.

NCS: Lacquered MDF any NCS.

Power strip with sockets

Name	Size	Fits	Art no
Space power strip, 2 sockets	1795	height 1936 mm, 2 doors high	208050
Space power strip, 3 sockets	1345	height 1487 mm, 3 doors high	208051
Space power strip, 4 sockets	1795	height 1936 mm, 4 doors high	208052

In addition, a USB port with 2 sockets can also be mounted.

Power strip with sockets 45x56, Alu look (Max 300 w per socket)



Power strips with sockets are customized for Space. Complete with movable shelves to store for example a computer.

Power strip with sockets – Accessories

Name	Size	Info	Art no
Space power cable with connection	2.5 m	220 volt/ 2400 Watt Max 8 sockets per cable	208040
Space extension cable, quick connection	410 mm	Mounted between every power strip with sockets	208041
Space T-coupling, quick		1 per power strip	208042

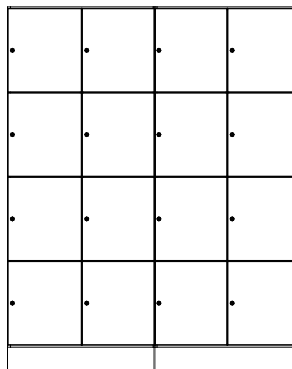

16 lockers with power sockets, in any NCS Example

Name	Art no
Space Frame double high, power (x2)	205523
Space shelf double fixed, power (x12)	205121
Space door low, cabinet lock (x16)	202121
Space power strip, 4 sockets (x4)	208052
Space power cable with connection (x2)	208040
Space cover strip single, power (x2)	208032

Doors and cover panels for Space are on pages 50–51.

Dimensions: Width x Height x Depth.



Stuff cork box and shelf keeps smaller items in order.

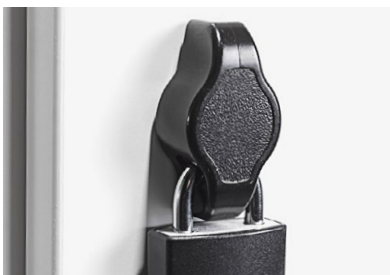

Padlock fittings, excluding padlocks.



Cabinet lock incl. 2 keys as standard.



RFID-locks EM or Mifare.



Anchor hook, fixed above panel.



Code lock/personal storage.

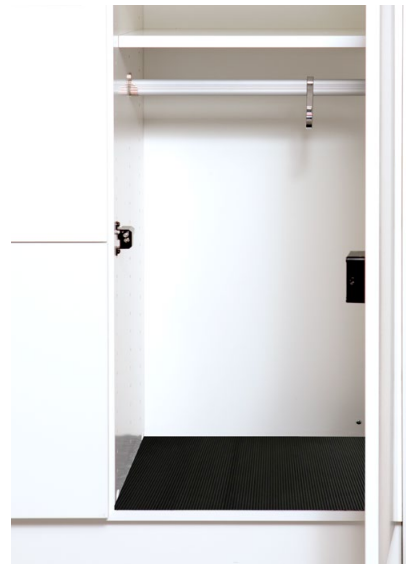

Storage compartment fitted with clothes rail, clothes hook and carpet. Carpet in narrow grooved black rubber, 3 mm.

Accessories

Name	Material	Size	Art no
Space single clothes rail	Aluminum	356	209009
Space double clothes rail	Aluminum	371	209010
Hook, for clothes rail	Alu look		830006
Anchor hook, fixed above panel	Alu look		830899
Stuff cork box	Cork	90x44x347	890101
Stuff shelf cork box	White aluminum	97x80x350	890201
Space single carpet	Black rubber	362x454	209026
Space single carpet shoe shelf	Black rubber	363x475	209023
Space single carpet open drawer	Black rubber	363x944	209025
Space double carpet	Black rubber	370x454	209027
Space double carpet wardrobe	Black rubber	757x454	209028
Space double carpet shoe shelf	Black rubber	758x475	209022
Space double carpet open drawer	Black rubber	773x455	209024

Master key

Name	Lock type	Art no
Master key	Cabinet locks	840913
Alternative locks, addition		
Name	Info	Art no
Padlock fitting	Black (padlock not incl.)	830915
Combination lock	Black, for personal storage	
RFID-lock	For personal/public storage	
Coin lock		

Dimensions: Width x Height x Depth. **Frame, front and back:** 16 mm. **Leg stand Height:** 160 mm.

Inside: Clothes hook and 3 compartments in laminate. **Recommended lock type:** RFID.

Contact TreCe for more information.

Fjäll

Storage locker

All frames and fronts are as standard in lacquered MDF.

Choose any NCS color on frames and fronts.

Fjäll is fitted with shelves and back in white MFC laminate.



Textile boxes in light gray needle felt. Available with or without dividers.

Fjäll frame with door excluding locks

Name	Size	Art no
(A) Fjäll 480 right-hung door*	720x1296x396	221120
(B) Fjäll 480 left-hung door*	720x1296x396	221110
(C) Fjäll 720 right-hung door	720x1296x396	221130
(D) Fjäll 720 left-hung door	720x1296x396	221140

*Can not be placed freestanding.

Legs White pigmented solid ash with 4 adjustable feet

Name	Size	Art no
Fjäll legs 720	720x160x396	222010
Fjäll legs 1200	1200x160x396	222011

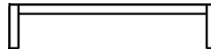

Combinations

720x1456x396

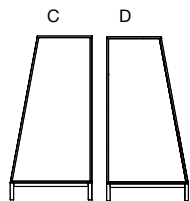

Legs 720 Legs 720

Fjäll C 221130

Fjäll D 221140

Legs 720 (x2) 222010

1200x1456x396

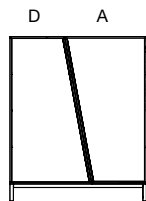

Legs 1200

Fjäll D 221140

Fjäll A 221120

Legs 1200 222011

1920x1456x396

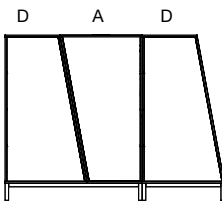

Legs 1200 Legs 720

Fjäll D (x2) 221140

Fjäll A 221120

Legs 1200 222011

Legs 720 222010

2400x1456x396

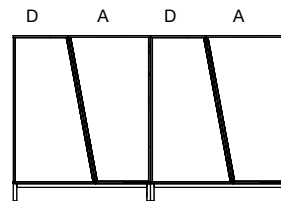

Legs 1200 Legs 1200

Fjäll D (x2) 221140

Fjäll A (x2) 221120

Legs 1200 (x2) 222011

2640x1456x396

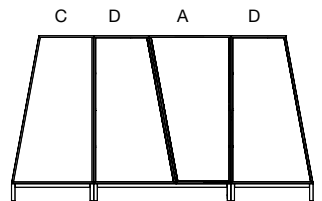

Legs 720 Legs 1200 Legs 720

Fjäll C 221130

Fjäll D (x2) 221140

Fjäll A 221120

Legs 720 (x2) 222010

Legs 1200 222011

Accessories

Name	Size	Art no
Vide, box	298x345x300	223001
Vide, box with divider	298x345x300	223002

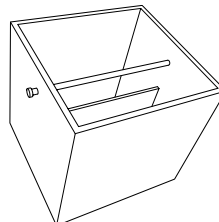

Dimensions: Width x Height x Depth.

Office

Personal storage

Office is a product family designed to meet the needs of the modern office. Smart solutions that focus on function and with a low environmental impact. Made from needled blanket with 7% wool, 93% polyester, and with details in untreated leather.

Sustainability & Material

- The felt meets OekoTex 100, class I (Products for children up to 3 years)
- Untreated leather
- Free from prohibited azo dyes, carcinogenic and allergenic dyes, phthalates, formaldehyde, pesticides, heavy metals, certain chlorine and tin organics, biologically active products and flame retardants.

Office Bag

Available in two colors, anthracite and light gray. Made of needled felt with 7% wool and 93% polyester. Leather details. Several compartments. Shoulder strap.

- Business card holder in leather
- Pen holder in leather

Name	Size	Anthracite	Light gray
Office Bag	360x310x170	830808	830818



Office Backpack, 15 liter

Needled felt with 7% wool, 93% polyester and leather details.

- Handle
- Magnetic closure with 2 positions, hidden in the lining
- Business card holder in leather
- Adjustable shoulder straps with details in leather
- Push buttons on the side for adjusting the depth
- Water resistant bottom
- Integrated rain cover hidden in the bottom with zipper.
- Holds 15L
- Laptop compartment
- Pen holder in leather for 3 pens
- Pocket for accessories

Name	Size	Anthracite
Office Backpack, 15 L	310x400x135	830500



Dimensions: Width x Height x Depth.



Office Sleeve

Laptop case suitable for most laptop computers. Needed felt with 7% wool and 93% polyester. Leather details and top opening with velcro close.

Name	Fits	Size	Anthracite	Light gray
Office Sleeve S	13,3"	250x360	830700	830710
Office Sleeve M	13,3"-14,5"	280x400	830701	830711
Office Sleeve L	14,5"-15,6"	310x440	830720	830721



Office Pouch

Practical small bag in needed felt with 7% wool and 93% polyester, for cables, keys, USB-sticks etc.

Name	Size	Anthracite	Light gray
Office pouch	175x160x50	830600	830610

Accessories

Hanger, Office bag

Practical hanger that is easily attached to the table top. Folds together after use and easily stored in your pocket.

Name	Size	Art no
Bag hanger, mobile	Ø 35 mm	830880



Dimensions: Width x Height x Depth. **Frame:** 19 mm. **Front:** 16 mm.

Mounting strip is included in all wall-mounted products.

NCS refers to product lacquered in one optional NCS color.

CombiLine

Lockers

Lockers for personal or public storage. Cabinet locks included as standard with 2 keys. The locks are adapted to a master key system and the lockers can be fitted with mail inlets and mail shelves.

The storage compartments are highly customizable and fit most areas. Standard widths: 310 mm, 605 mm and 900 mm. Alternative locks can be ordered at additions, see pages 17 and 19.

Specifications →

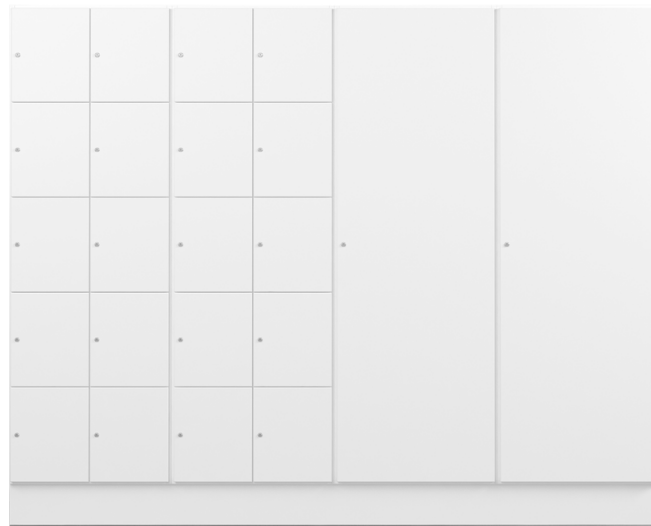

Two lockers FF60/10 combined with two wardrobes KLE60. Depth 370 mm. All with cabinet locks.

CombiLine Lockers Wall Depth 370mm, incl. cabinet locks

Size inside locker: 274x333x358 mm. **Locks** incl. 2 keys.

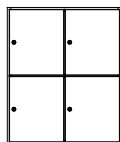

FFV60/4
605x723x370

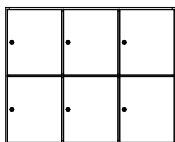

FFV90/6
900x723x370

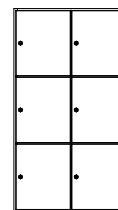

FFV60/6
605x1075x370

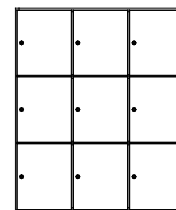

FFV90/9
900x1075x370

Height 723 mm, Depth 370 mm

Name	White	NCS	Beech	Birch	Oak
FFV60/4	841242	849242L	843242	845242	847242
FFV90/6	841243	849243L	843243	845243	847243

Height 1075 mm, Depth 370 mm

Name	White	NCS	Beech	Birch	Oak
FFV60/6	841252	849252L	843252	845252	847252
FFV90/9	841253	849253L	843253	845253	847253

Dimensions: Width x Height x Depth. **Frame:** 19 mm. **Front:** 16 mm. **Plinth:** 157 mm

NCS refers to product lacquered in one optional NCS color.

Mounting strip is included in all wall-mounted products.

CombiLine Lockers Floor Depth 370 mm, incl. cabinet locks

Size inside locker: 274x333x358 mm. **Locks** incl. 2 keys.

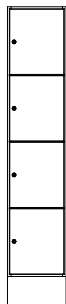

FF30/4
310x1584x370

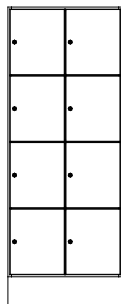

FF60/8
605x1584x370

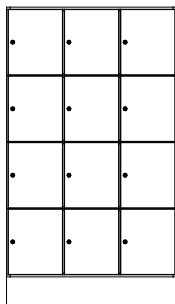

FF90/12
900x1584x370

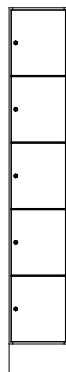

FF30/5
310x1936x370

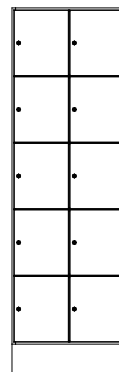

FF60/10
605x1936x370

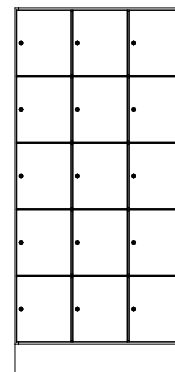

FF90/15
900x1936x370

Height 1584 mm, Depth 370 mm

Name	White	NCS	Beech	Birch	Oak
FF30/4	841231	849231L	843231	845231	847231
FF60/8	841232	849232L	843232	845232	847232
FF90/12	841233	849233L	843233	845233	847233

Height 1936 mm, Depth 370 mm

Name	White	NCS	Beech	Birch	Oak
FF30/5	841221	849221L	843221	845221	847221
FF60/10	841222	849222L	843222	845222	847222
FF90/15	841223	849223L	843223	845223	847223

CombiLine Lockers Floor Depth 570 mm, incl. cabinet locks

Size inside locker: 274x567x558 mm. **Locks** incl. 2 keys.

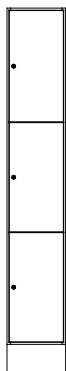

FF30/3
310x1936x570

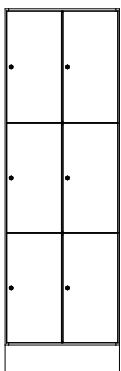

FF60/6
605x1936x570

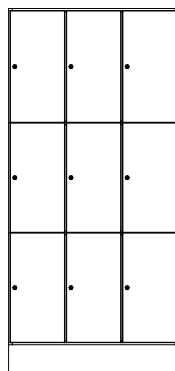

FF90/9
900x1936x570

Height 1936 mm, Depth 570 mm

Name	White	NCS	Beech	Birch	Oak
FF30/3	841211	849211L	843211	845211	847211
FF60/6	841212	849212L	843212	845212	847212
FF90/9	841213	849213L	843213	845213	847213

Accessories

Mail shelf incl. mounting strip.

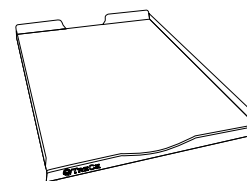

Name	Fits	Size	Art no
Mail shelf, acrylic			810919
Mail inlet		Height 22 mm	840911
Stuff cork box		90x44x347	890101
Stuff shelf cork box		97x80x350	890201
Carpet, black, fine ribbed rubber	Depth 570	270x550x3	840950
Master key	Cabinet locks		840913
Mirror, door		230x400	840912

Alternative locks, addition

Name	Info	Art no
Padlock fitting	Black (padlock not incl.)	830915
Combination lock	Black, for personal storage	
RFID-lock	For personal/public storage	
Coin lock		

Shelves, Depth 570 mm

Name	Material	Art no
Shelves 30/570	White	821913
Shelves 30/570	NCS	829913L
Shelves 30/570	Beech	823913
Shelves 30/570	Birch	825913
Shelves 30/570	Oak	827913

Dimensions: Width x Height x Depth (height incl. plinth). **Frame:** 19 mm. **Front:** 16 mm. **Plinth:** 157 mm.
NCS refers to product lacquered in one optional NCS color.

CombiLine

Wardrobe

Clothes rail and hat rack always included as standard.
Master key to all locks can be ordered separately.
Standard height: 1936 mm.

Specifications →



Two lockers FF60/6 combined with two wardrobes KLD60, all with RFID-locks.

CombiLine Wardrobe, Floor

Hat rack and clothes rail included.
Cabinet locks not included, available as accessory for KL60.

Hat rack, clothes rail and cabinet lock with 2 keys are included.

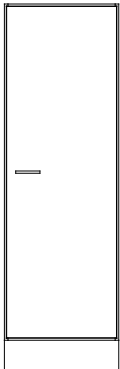

KL60
605x1936x570

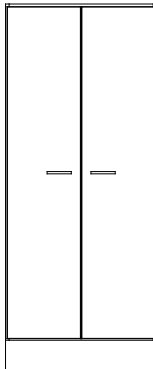

KL80
800x1936x570



KLE30
310x1936x570

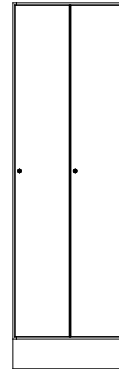

KLD60
605x1936x570

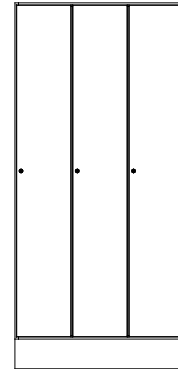

KLT90
900x1936x570

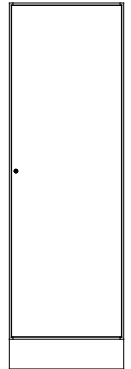

KLE60
605x1936x370

Height 1936 mm, Depth 570 mm

Name	White	NCS	Beech	Birch	Oak
KL60	841115	849115L	843115	845115	847115
KL80	841116	849116L	843116	845116	847116

Height 1936 mm, Depth 570 mm

Name	White	NCS	Beech	Birch	Oak
KLE30	841111	849111L	843111	845111	847111
KLD60	841112	849112L	843112	845112	847112
KLT90	841113	849113L	843113	845113	847113

Height 1936 mm, Depth 370 mm

Name	White	NCS	Beech	Birch	Oak
KLE60	841114	849114L	843114	845114	847114

Note! KLE60 must be secured to a wall due to tipping risk.

Dimensions: Width x Height x Depth.



Stuff cork box and shelf keeps smaller items in order.



Padlock fittings, excluding. padlocks.



Code lock/personal storage.



RFID-locks EM or Mifare.



Cabinet lock as standard, incl. 2 keys.

Accessories

Name	Size	Fits	Art no
Mirror, door	230x400		840912
Stuff cork box	90x44x347		890101
Stuff shelf cork box	97x80x350		890201

Carpet, black, fine ribbed rubber, 3 mm

Name	Size	Fits	Art no
Carpet, black	270x550	KLE30, KLD60, KLT90	840950
Carpet, black	565x350	KLE60	840951
Carpet, black	565x550	KL60	840952
Carpet, black	760x550	KL80	840953

Master key

Name	Lock type	Art no
Master key	Cabinet locks	840913

Alternative locks, addition

Name	Info	Art no
Padlock fitting	Black (padlock not incl.)	830915
Combination lock	Black, for personal storage	
RFID-lock	For personal/public storage	
Coin lock		

Dimensions: Width x Height x Depth (height incl. plinth). **Frame:** 19 mm. **Front:** 16 mm. **Plinth:** 157 mm.
NCS refers to product lacquered in one optional NCS color.

CombiLine

Office shelving/cupboards

Shelves and cabinets for storage of large volumes. Can be ordered in different widths, heights and depth. Possibility to choose glass doors, glass shelves, drawers or folder drawers.

Standard widths: 605 mm and 800 mm. Standard depth: 370 mm and 570 mm. Worktops for the lower models are also available as a supplement, see page 98.

Tips!

Mix-n-match as you like. Choose doors in wood or glass. See page 101. If you would like other handles contact TreCe. Accessories such as legs, wheels and drawers can be found on page 102–103. Worktops are on page 98.

Specifications →



Office shelving/cupboards are available in the depth 370 and 570 mm.

CombiLine Office shelving/cupboards, Floor

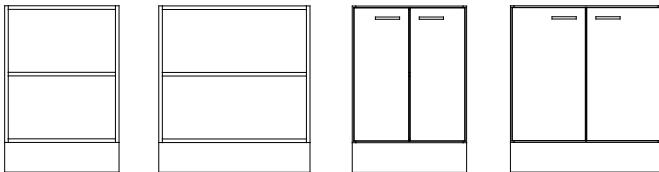

KH60/2
605x880x370

KH80/2
800x880x370

KS60/2
605x880x370

KS80/2
800x880x370

Height 880 mm, Depth 370 mm

Name	White	NCS	Beech	Birch	Oak
KH60/2	831111	839111L	833111	835111	837111
KH80/2	831123	839123L	833123	835123	837123
KS60/2	831211	839211L	833211	835211	837211
KS80/2	831127	839127L	833127	835127	837127

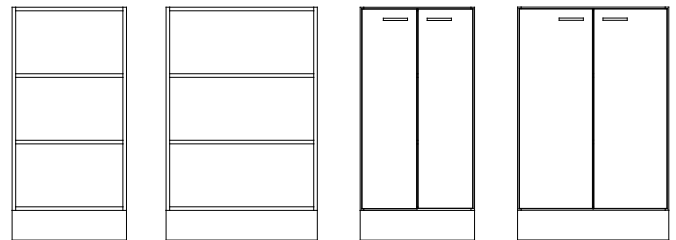

KH60/3
605x1232x370

KH80/3
800x1232x370

KS60/3
605x1232x370

KS80/3
800x1232x370

Height 1232 mm, Depth 370 mm

Name	White	NCS	Beech	Birch	Oak
KH60/3	831115	839115L	833115	835115	837115
KH80/3	831124	839124L	833124	835124	837124
KS60/3	831219	839219L	833219	835219	837219
KS80/3	831128	839128L	833128	835128	837128

Dimensions: Width x Height x Depth (height incl. plinth). **Frame:** 19 mm. **Front:** 16 mm. **Plinth:** 157 mm.
NCS refers to product lacquered in one optional NCS color.

CombiLine Office shelving/cupboards, Floor

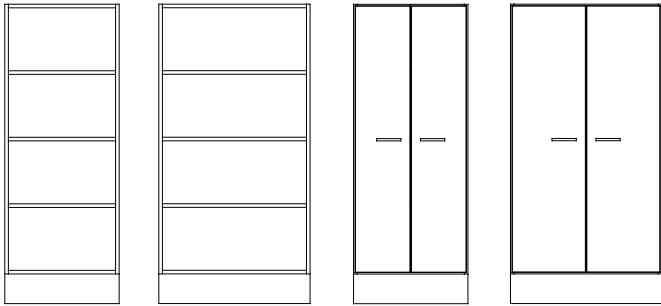

KH60/4
605x1584x370

KH80/4
800x1584x370

KS60/4
605x1584x370

KS80/4
800x1584x370

Height 1584 mm, Depth 370 mm

Name	White	NCS	Beech	Birch	Oak
KH60/4	831116	839116L	833116	835116	837116
KH80/4	831125	839125L	833125	835125	837125
KS60/4	831220	839220L	833220	835220	837220
KS80/4	831129	839129L	833129	835129	837129

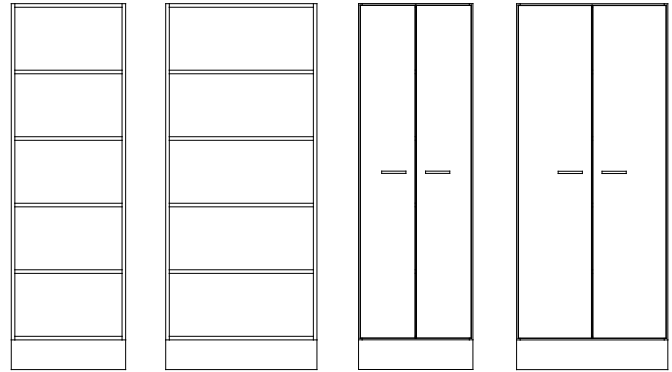

KH60/5
605x1936x370

KH80/5
800x1936x370

KS60/5
605x1936x370

KS80/5
800x1936x370

Height 1936 mm, Depth 370 mm

Name	White	NCS	Beech	Birch	Oak
KH60/5	831112	839112L	833112	835112	837112
KH80/5	831126	839126L	833126	835126	837126
KS60/5	831212	839212L	833212	835212	837212
KS80/5	831130	839130L	833130	835130	837130

CombiLine Office shelving/cupboards, Floor

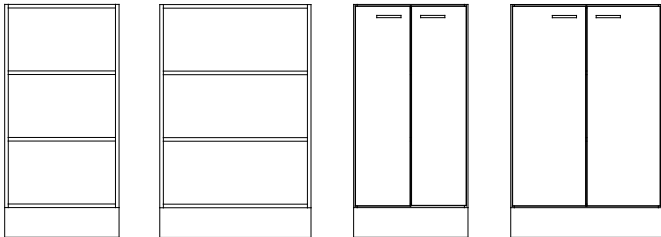

KHD60/3
605x1232x570

KHD80/3
800x1232x570

KSD60/3
605x1232x570

KSD80/3
800x1232x570

Height 1232 mm, Depth 570 mm

Name	White	NCS	Beech	Birch	Oak
KHD60/3	861115	869115L	863115	865115	867115
KHD80/3	831131	839131L	833131	835131	837131
KSD60/3	861219	869219L	863219	865219	867219
KSD80/3	831134	839134L	833134	835134	837134

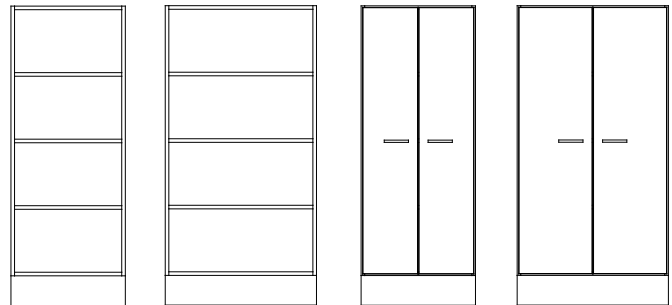

KHD60/4
605x1584x570

KHD80/4
800x1584x570

KSD60/4
605x1584x570

KSD80/4
800x1584x570

Height 1584 mm, Depth 570 mm

Name	White	NCS	Beech	Birch	Oak
KHD60/4	861116	869116L	863116	865116	867116
KHD80/4	831132	839132L	833132	835132	837132
KSD60/4	861220	869220L	863220	865220	867220
KSD80/4	831135	839135L	833135	835135	837135

Dimensions: Width x Height x Depth (height incl. plinth). **Frame:** 19 mm. **Front:** 16 mm. **Plinth:** 157 mm.
NCS refers to product lacquered in one optional NCS color.

CombiLine Office shelving/cupboards, Floor

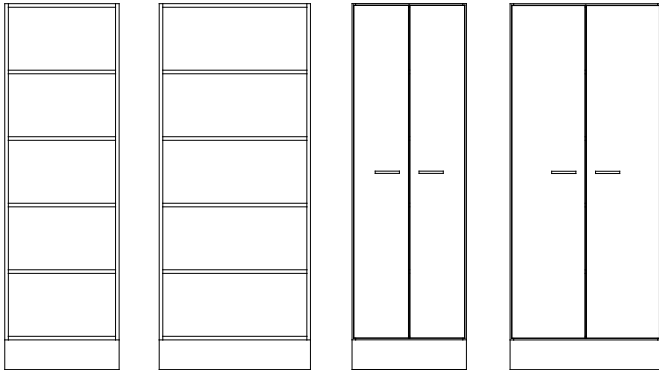

KHD60/5
605x1936x570

KHD80/5
800x1936x570

KSD60/5
605x1936x570

KSD80/5
800x1936x570

Height 1936 mm, Depth 570 mm

Name	White	NCS	Beech	Birch	Oak
KHD60/5	861112	869112L	863112	865112	867112
KHD80/5	831133	839133L	833133	835133	837133
KSD60/5	861212	869212L	863212	865212	867212
KSD80/5	831136	839136L	833136	835136	837136

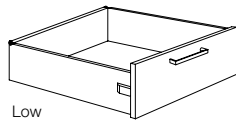

Drawer low, 70% expansion

Depth 570 mm (Max 30 kg/drawer)

Name	White	NCS	Beech	Birch	Oak
Low 30/570	831702	839702L	833702	835702	837702
Low 60/570	831703	839703L	833703	835703	837703
Low 80/570	831705	839705L	833705	835705	837705

Drawer low, 100% expansion

Depth 570 mm (Max 35 kg/drawer)

Name	White	NCS	Beech	Birch	Oak
Low 30/570	831720	839720L	833720	835720	837720
Low 60/570	831721	839721L	833721	835721	837721
Low 80/570	831722	839722L	833722	835722	837722

Folder drawer



Width 600 and 800 mm, Depth 570 mm

Name	White	NCS	Beech	Birch	Oak
ML60/570 1xA4	831727	839727L	833727	835727	837727
ML80/570 2xA4	831729	839729L	833729	835729	837729

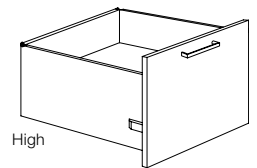

Drawer high, 70% expansion

Depth 570 mm (Max 30 kg/drawer)

Name	White	NCS	Beech	Birch	Oak
High 60/570	831704	839704L	833704	835704	837704
High 80/570	831709	839709L	833709	835709	837709

Drawer high, 100% expansion

Depth 570 mm (Max 50 kg/drawer)

Name	White	NCS	Beech	Birch	Oak
High 60/570	831714	839714L	833714	835714	837714
High 80/570	831719	839719L	833719	835719	837719

Cabinet locks

Name	Art no
Cabinet locks, different lock numbers, incl 2 keys	830910
Addition, identical locks, Cabinet locks	830985
Master key Cabinet locks	840913

If you would like other lock types, see page 61.

Dimensions: Width x Height x Depth (height incl. plinth). **Frame:** 19 mm. **Plinth:** 157 mm.

Mounting strip is included in all wall-mounted products.

NCS refers to product lacquered in one optional NCS color.

CombiLine

Magazine shelf Expo

Display area in black or white powder-coated steel for showing newspapers, books or reference materials. Plenty of storage space behind the display areas. Mounting strip is included with all wall modules.

Our standard widths are 310 mm, 605 mm and 900 mm.

V = White shelves

S = Black shelves

Specifications →



CombiLine Magazine shelf Expo, Wall

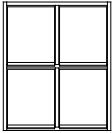

EXPO 60/4
605x723x370

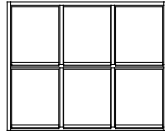

EXPO 90/6
900x723x370

Height 723 mm, Depth 370 mm

Name	White	NCS	Beech	Birch	Oak
EXPO 60/4V	841332V	849332VL	843332V	845332V	847332V
EXPO 60/4S	841332S	849332SL	843332S	845332S	847332S
EXPO 90/6V	841333V	849333VL	843333V	845333V	847333V
EXPO 90/6S	841333S	849333SL	843333S	845333S	847333S



EXPO 60/6
605x1075x370

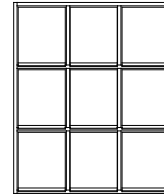

EXPO 90/9
900x1075x370

Height 1075 mm, Depth 370 mm

Name	White	NCS	Beech	Birch	Oak
EXPO 60/6V	841342V	849342VL	843342V	845342V	847342V
EXPO 60/6S	841342S	849342SL	843342S	845342S	847342S
EXPO 90/9V	841343V	849343VL	843343V	845343V	847343V
EXPO 90/9S	841343S	849343SL	843343S	845343S	847343S

CombiLine Magazine shelf Expo, Floor

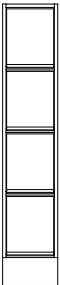

EXPO 30/4
310x1584x370

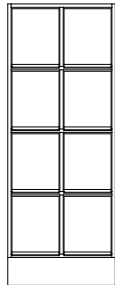

EXPO 60/8
605x1584x370

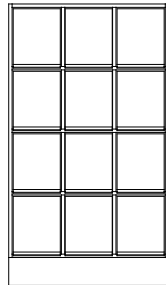

EXPO 90/12
900x1584x370

Height 1584 mm, Depth 370 mm

Name	White	NCS	Beech	Birch	Oak
EXPO 30/4V	841321V	849321VL	843321V	845321V	847321V
EXPO 30/4S	841321S	849321SL	843321S	845321S	847321S
EXPO 60/8V	841322V	849322VL	843322V	845322V	847322V
EXPO 60/8S	841322S	849322SL	843322S	845322S	847322S
EXPO 90/12V	841323V	849323VL	843323V	845323V	847323V
EXPO 90/12S	841323S	849323SL	843323S	845323S	847323S



EXPO 30/5
310x1936x370



EXPO 60/10
605x1936x370

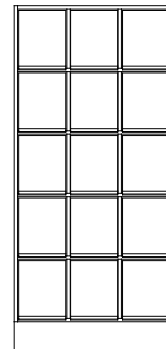

EXPO 90/15
900x1936x370

Height 1936 mm, Depth 370 mm

Name	White	NCS	Beech	Birch	Oak
EXPO 30/5V	841311V	849311VL	843311V	845311V	847311V
EXPO 30/5S	841311S	849311SL	843311S	845311S	847311S
EXPO 60/10V	841312V	849312VL	843312V	845312V	847312V
EXPO 60/10S	841312S	849312SL	843312S	845312S	847312S
EXPO 90/15V	841313V	849313VL	843313V	845313V	847313V
EXPO 90/15S	841313S	849313SL	843313S	845313S	847313S

Dimensions: Width x Height x Depth (height incl. plinth). **Frame:** 19 mm. **Plinth:** 157 mm.

Mounting strip is included in all wall-mounted products.

NCS refers to product lacquered in one optional NCS color.

CombiLine

Combi shelf

Combi shelf is our most adaptable storage furniture. Build from floor to ceiling. Standard widths: 310 mm, 605 mm and 900 mm.

Take advantage of wall surfaces with a wall mounted Combi shelf and create a unique module by combining accessories. Accessories like leg and wheel sets, doors, see pages 101–103. Worktops for the lower modules on page 98.

Specifications →



Add a worktop to low modules for a more integrated look.

CombiLine Combi shelf, Wall



KBV30/2
310x723x370

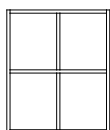

KBV60/2
605x723x370

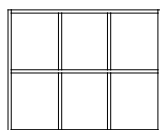

KBV90/2
900x723x370

Height 723 mm, Depth 370 mm

Name	White	NCS	Beech	Birch	Oak
KBV30/2	831615	839615L	833615	835615	837615
KBV60/2	831625	839625L	833625	835625	837625
KBV90/2	831635	839635L	833635	835635	837635



KBV30/3
310x1075x370

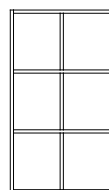

KBV60/3
605x1075x370

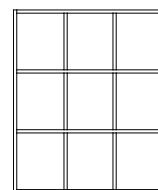

KBV90/3
900x1075x370

Height 1075 mm, Depth 370 mm

Name	White	NCS	Beech	Birch	Oak
KBV30/3	831616	839616L	833616	835616	837616
KBV60/3	831626	839626L	833626	835626	837626
KBV90/3	831636	839636L	833636	835636	837636

CombiLine Combi shelf, Floor



KBH30/2
310x880x370

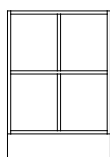

KBH60/2
605x880x370

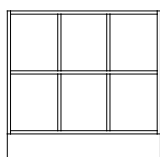

KBH90/2
900x880x370

Height 880 mm, Depth 370 mm

Name	White	NCS	Beech	Birch	Oak
KBH30/2	831611	839611L	833611	835611	837611
KBH60/2	831621	839621L	833621	835621	837621
KBH90/2	831631	839631L	833631	835631	837631



KBH30/3
310x1232x370

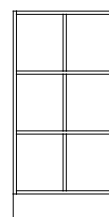

KBH60/3
605x1232x370

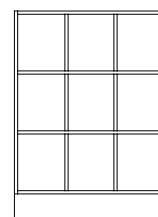

KBH90/3
900x1232x370

Height 1232 mm, Depth 370 mm

Name	White	NCS	Beech	Birch	Oak
KBH30/3	831612	839612L	833612	835612	837612
KBH60/3	831622	839622L	833622	835622	837622
KBH90/3	831632	839632L	833632	835632	837632

Dimensions: Width x Height x Depth (height incl. plinth). **Frame:** 19 mm. **Plinth:** 157 mm.
NCS refers to product lacquered in one optional NCS color.

CombiLine Combi shelf, Floor

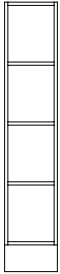

KBH30/4
310x1584x370

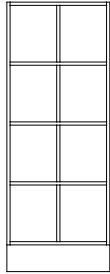

KBH60/4
605x1584x370

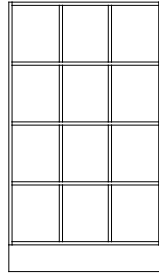

KBH90/4
900x1584x370

Height 1584 mm, Depth 370 mm

Name	White	NCS	Beech	Birch	Oak
KBH30/4	831613	839613L	833613	835613	837613
KBH60/4	831623	839623L	833623	835623	837623
KBH90/4	831633	839633L	833633	835633	837633

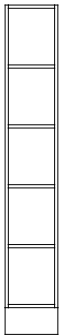

KBH30/5
310x1936x370

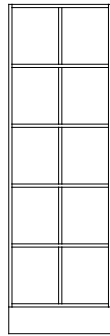

KBH60/5
605x1936x370

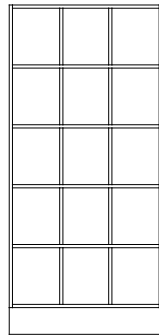

KBH90/5
900x1936x370

Height 1936 mm, Depth 370 mm

Name	White	NCS	Beech	Birch	Oak
KBH30/5	831614	839614L	833614	835614	837614
KBH60/5	831624	839624L	833624	835624	837624
KBH90/5	831634	839634L	833634	835634	837634

ABOUT COMBILINE:

MFC laminated and lacquered surfaces within CombiLine have a chip core, with the exception of some shelves. Back, frame, doors and edge strips have the same color/wood as other parts as standard, unless otherwise stated.

Frame: Thickness 19 mm, 0,8 mm straight ABS-lipping.

- MFC laminate white, beech, birch and oak.
- Lacquered available in any NCS-color.

Back: Thickness 12 mm, laminate inside and outside.

Plinth: Every module has its own front and back plinth with 4 adjustable feet (does not apply to recycling units with loading ramps). Plinth 157 mm. Can be replaced with:

- Bottom plate with adjustable stainless steel legs, height 157 mm.
- Bottom plate with lockable wheels, height 104 mm.

Doors: Thickness 16 mm, with 2 mm straight ABS-lipping.

- White lacquered UV-treated MFC laminate (NCS S 0500-N), or MFC laminate in beech/birch/oak.
- Lacquered in any NCS color.
- Self closing concealed hinges with integrated soft closing (does not apply to products with aximat hinges with 180° opening).
- Single doors are right-hung as standard.

Drawer front: Thickness 16 mm. Med 2 mm straight ABS-lipping.

- White lacquered UV treated MFC laminate (NCS 0500-N) and MFC laminate in beech/birch/oak.
- Lacquered available in any NCS-color.

Drawers: Drawers with depth 570 mm are soft-closing.

- Extension capacity of 70%, max load 30 kg.
- Extension capacity of 100%, max load 35 kg (excl. recycling units).
- Extension capacity of 100%, max load 50 kg.

Shelves: All shelves are adjustable and mounted with milled-in shelf support. Drill division c/c 32 mm.

- 310 – 605 mm have a chip core.
- 800 – 900 mm have a pine lamellar core.

Recycling unit MDL60/MD60/MDH60/MD65/MD70:

The bottom plate is equipped with an access ramp in stainless steel.

- Doors with aximat hinges for 180 degree opening for easy access to recycling containers.

Mail shelves: Adjustable with pull-out function and mounting strip, subdivision c/c 96 mm.

- Mail shelves in acrylic have integrated name slots.
- Mail shelves in powder coated steel white or black are available as an addition.

Steel doors mail sorting: White powder coated steel. Shelves inside in the same material as frame, 19 mm.

- Incl. lock and 2 keys with individual lock number.
- Inlet 22 mm. Open door gives a free space of 90 mm.

Wall modules: White lacquered mounting strip in steel is included for all wall modules.

Lock types: Cabinet locks, padlock fitting, code locks and RFID-lock (EM & Mifare).

Fitting pieces /Cover panels: Available as accessories in the same color/material as frame. Width, height and depth adapted to your requirements.

Handles: Stainless steel bow handles as standard, if you would like black or white handles, please not on order.

- Standard handles c/c 128 mm.
- Grip handles 40 mm.

Dimensions: Width x Height x Depth. **Frame:** 19 mm. **Front:** 16 mm.

Mounting strip is included in all wall-mounted products.

NCS refers to product lacquered in one optional NCS color.

CombiLine

Wall shelving/cupboards

Wall-mounted shelves and cabinets serve as space saving alternatives or complements to our floor standing modules. Standard heights: 371 mm, 723 mm and 1075 mm.

Note! Write on your order if the handles are to be placed at the bottom or top of the cabinets.

Specifications →



CombiLine Wall shelving/cupboards



VH30/1

310x371x370



VH60/1

605x371x370



VH80/1

800x371x370



VH90/1

900x371x370



VS30/1

310x371x370

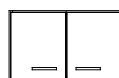

VS60/1

605x371x370

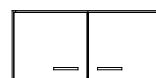

VS80/1

800x371x370

Height 371 mm, Depth 370 mm

Name	White	NCS	Beech	Birch	Oak
VH30/1	831322	839322L	833322	835322	837322
VH60/1	831313	839313L	833313	835313	837313
VH80/1	831331	839331L	833331	835331	837331
VH90/1	831314	839314L	833314	835314	837314

Name	White	NCS	Beech	Birch	Oak
VS30/1	831422	839422L	833422	835422	837422
VS60/1	831413	839413L	833413	835413	837413
VS80/1	831433	839433L	833433	835433	837433



VH30/2

310x723x370

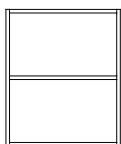

VH60/2

605x723x370

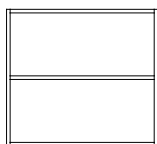

VH80/2

800x723x370

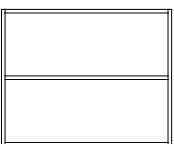

VH90/2

900x723x370



VS30/2

310x723x370

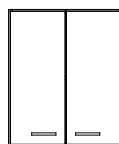

VS60/2

605x723x370

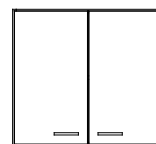

VS80/2

800x723x370

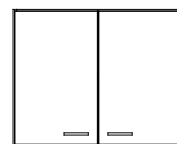

VS80/2

900x723x370

Height 723 mm, Depth 370 mm

Name	White	NCS	Beech	Birch	Oak
VH30/2	831321	839321L	833321	835321	837321
VH60/2	831311	839311L	833311	835311	837311
VH80/2	831332	839332L	833332	835332	837332
VH90/2	831312	839312L	833312	835312	837312

Name	White	NCS	Beech	Birch	Oak
VS30/2	831421	839421L	833421	835421	837421
VS60/2	831411	839411L	833411	835411	837411
VS80/2	831432	839432L	833432	835432	837432
VS90/2	831412	839412L	833412	835412	837412

Dimensions: Width x Height x Depth (height incl. plinth). **Frame:** 19 mm. **Front:** 16 mm.

Mounting strip is included in all wall-mounted products.

NCS refers to product lacquered in one optional NCS color.

CombiLine Wall shelving/cupboards

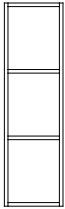

VH30/3

310x1075x370

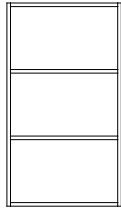

VH60/3

605x1075x370

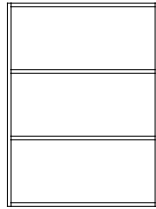

VH80/3

800x1075x370

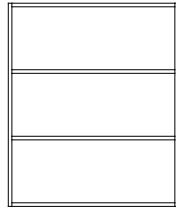

VH90/3

900x1075x370



VS30/3

310x1075x370

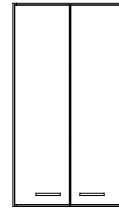

VS60/3

605x1075x370

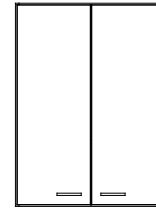

VS80/3

800x1075x370

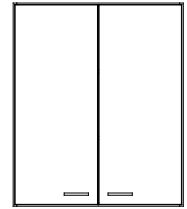

VS90/3

900x1075x370

Height 1075 mm, Depth 370 mm

Name	White	NCS	Beech	Birch	Oak
VH30/3	831323	839323L	833323	835323	837323
VH60/3	831315	839315L	833315	835315	837315
VH80/3	831333	839333L	833333	835333	837333
VH90/3	831316	839316L	833316	835316	837316

Name	White	NCS	Beech	Birch	Oak
VS30/3	831423	839423L	833423	835423	837423
VS60/3	831415	839415L	833415	835415	837415
VS80/3	831434	839434L	833434	835434	837434
VS90/3	831417	839417L	833417	835417	837417

Dimensions: Width x Height x Depth (height incl. plinth). **Frame:** 19 mm. **Front:** 16 mm. **Plinth:** 157 mm.
NCS refers to product lacquered in one optional NCS color.

CombiLine

Cabinet

Space efficient cabinets that utilize all of the offices quadratic and cubic meters. Available as standard version in white, or choose freely among all NCS colors or beech, birch and oak. Standard widths: 310 mm, 605 mm, 800 mm and 900 mm.

Stainless steel handles are standard. If you'd prefer black or white, please let us know when ordering. Legs, wheels and drawers can be found on page 102–103. Worktops on page 98.

Specifications →



Combination of 4 cabinets with width 605 mm, white worktop (F1040) with black lipping strip and black grip handles (40 mm).

CombiLine Cabinet

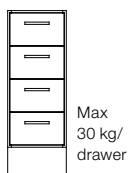

DL30/4L
310x880x570



DÖ30
310x 880x570



DS30
310x880x570

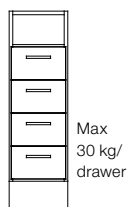

HDL30/4L
310x1057x570



HDÖ30
310x1057x570



HDS30
310x1057x570

Width 310 mm, Height 880 mm, Depth 570 mm

Name	White	NCS	Beech	Birch	Oak
DL30/4L	821611	829611L	823611	825611	827611
DÖ30	821612	829612L	823612	825612	827612
DS30	821613	829613L	823613	825613	827613

Width 310 mm, Height 1057 mm, Depth 570 mm

Name	White	NCS	Beech	Birch	Oak
HDL30/4L	821631	829631L	823631	825631	827631
HDÖ30	821632	829632L	823632	825632	827632
HDS30	821633	829633L	823633	825633	827633

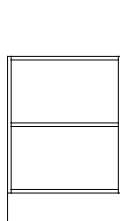

DÖ60
605x880x570

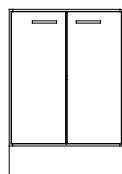

DS60
605x880x570



DL60/4L
605x880x570

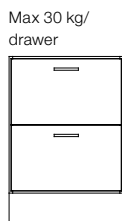

DL60/2L-30
605x880x570

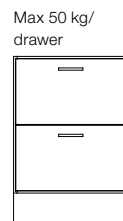

DL60/2L-50
605x880x570

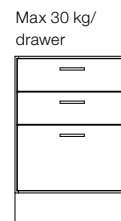

DL60/3L-30
605x880x570

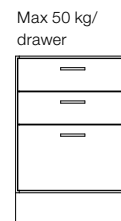

DL60/3L-50
605x880x570

Width 605 mm, Height 880 mm, Depth 570 mm

Name	White	NCS	Beech	Birch	Oak
DÖ60	821712	829712L	823712	825712	827712
DS60	821713	829713L	823713	825713	827713
DL60/4L	821711	829711L	823711	825711	827711

Name	White	NCS	Beech	Birch	Oak
DL60/2L-30	821714	829714L	823714	825714	827714
DL60/2L-50	821814	829814L	823814	825814	827814
DL60/3L-30	821715	829715L	823715	825715	827715
DL60/3L-50	821815	829815L	823815	825815	827815

Dimensions: Width x Height x Depth (height incl. plinth). **Frame:** 19 mm. **Front:** 16 mm. **Plinth:** 157 mm.

NCS refers to product lacquered in one optional NCS color.



Drawer holds 30 kg with 70% expansion, see page 64.



Drawer holds 30 kg with 100% expansion, see page 64.



Folder drawer 2xA4, see page 64.



Drawer inserts, see page 64.

CombiLine Cabinet

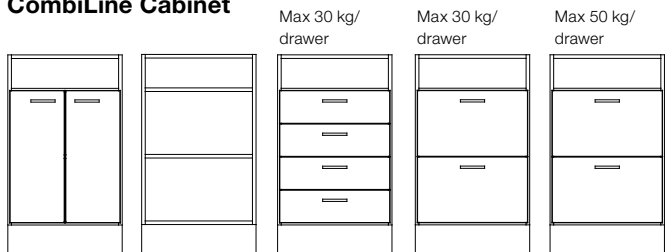

Max 30 kg/
drawer

Max 30 kg/
drawer

Max 50 kg/
drawer

HDS60

605x1057x570

HDÖ60

605x1057x570

HDL60/4L

605x1057x570

HDL60/2L-30

605x1057x570

HDL60/2L-50

605x1057x570

Width 605 mm, Height 1057 mm, Depth 570 mm

Name	White	NCS	Beech	Birch	Oak
HDS60	821733	829733L	823733	825733	827733
HDÖ60	821732	829732L	823732	825732	827732
HDL60/4L	821731	829731L	823731	825731	827731
HDL60/2L-30	821734	829734L	823734	825734	827734
HDL60/2L-50	821834	829834L	823834	825834	827834

Stainless steel handles are standard. If you'd prefer black or white, please let us know when ordering. Legs, wheels and drawers can be found on page 102–103. Worktops on page 98.

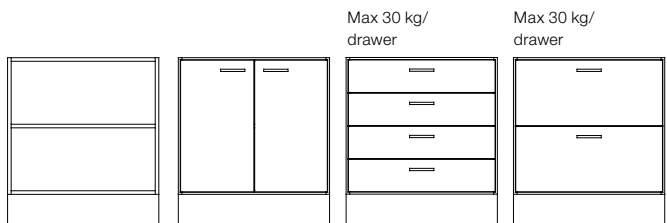

Max 30 kg/
drawer

Max 30 kg/
drawer

DÖ80

800x880x570

DS80

800x880x570

DL80/4L

800x880x570

DL80/2L-30

800x880x570

Width 800 mm, Height 1057 mm, Depth 570 mm

Name	White	NCS	Beech	Birch	Oak
DÖ80	821512	829512L	823512	825512	827512
DS80	821513	829513L	823513	825513	827513
DL80/4L	821514	829514L	823514	825514	827514
DL80/2L-30	821515	829515L	823515	825515	827515

Max 50 kg/
drawer

Max 30 kg/
drawer

Max 50 kg/
drawer

DL80/2L-50

800x880x570

DL80/3L-30

800x880x570

DL80/3L-50

605x880x570

Name	White	NCS	Beech	Birch	Oak
DL80/2L-50	821615	829615L	823615	825615	827615
DL80/3L-30	821516	829516L	823516	825516	827516
DL80/3L-50	821517	829517L	823517	825517	827517

Dimensions: Width x Height x Depth (height incl. plinth). **Frame:** 19 mm. **Front:** 16 mm. **Plinth:** 157 mm.
NCS refers to product lacquered in one optional NCS color.

CombiLine Cabinet

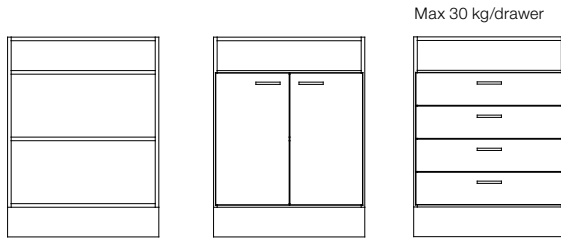

HDÖ80
800x1057x570

HDS80
800x1057x570

Max 30 kg/drawer

HDL80/4L
800x1057x570

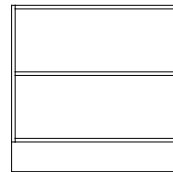

DÖ90
900x880x570

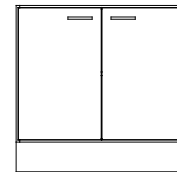

DS90
900x880x570

Max 30 kg/drawer

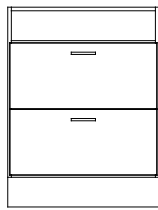

HDL80/2L-30
800x1057x570

Max 50 kg/drawer

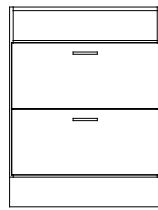

HDL80/2L-50
800x1057x570

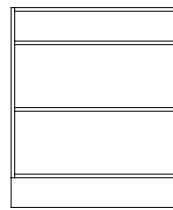

HDÖ90
900x1057x570

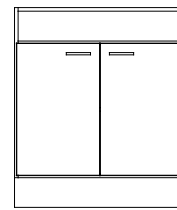

HDS90
900x1057x570

Width 800 mm, Height 1057 mm, Depth 570 mm

Name	White	NCS	Beech	Birch	Oak
HDÖ80	821532	829532L	823532	825532	827532
HDS80	821533	829533L	823533	825533	827533
HDL80/4L	821535	829535L	823535	825535	827535
HDL80/2L-30	821536	829536L	823536	825536	827536
HDL80/2L-50	821534	829534L	823534	825534	827534

Width 900 mm, Height 880 mm, Depth 570 mm

Name	White	NCS	Beech	Birch	Oak
DÖ90	821811	829811L	823811	825811	827811
DS90	821812	829812L	823812	825812	827812

Width 900 mm, Height 1057 mm, Depth 570 mm

Name	White	NCS	Beech	Birch	Oak
HDÖ90	821831	829831L	823831	825831	827831
HDS90	821832	829832L	823832	825832	827832

Accessories

Insert for drawer, white

Name	Fits	Max load	Expans.	Size/box	Art no
Insert 60/9 boxes	600 mm	30 kg	70 %	164x165	821011
Insert 80/9 boxes	800 mm	30 kg	70 %	164x230	821013
Insert 60/9 boxes	600 mm	35 kg	100 %	162x162	821012
Insert 80/9 boxes	800 mm	35 kg	100 %	164x226	821014

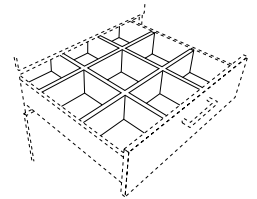

Folder drawer, depth 570 mm, 100% expansion, max 50 kg

Name	White	NCS	Beech	Birch	Oak
ML60/570 1xA4 600mm	831727	839727L	833727	835727	837727
ML80/570 2xA4 800mm	831729	839729L	833729	835729	837729
MLF60/570 folio folders mail 600mm	831827	839827L	833827	835827	837827

Accessories folio folders see page 79.

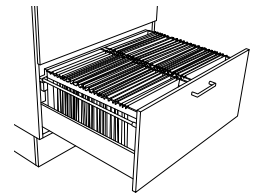

Corner module, 100x880x100 mm

Name	White	NCS	Beech	Birch	Oak
Corner module	821010	829010L	823010	825010	827010

When the corner module is used – extend both worktops with 50 mm. Corner module is aligned with plinth.

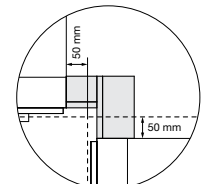
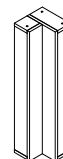

Dimensions: Width x Height x Depth (height incl. plinth). **Frame:** 19 mm. **Front:** 16 mm. **Plinth:** 157 mm.
NCS refers to product lacquered in one optional NCS color.

CombiLine

Printer cabinet

Printer cabinet in an ergonomic height which can easily be combined with other storage furniture.
Standard height: 704 mm.

Specifications →



CombiLine Printer cabinet

Max 30 kg/
drawer



SD60/3L
605x704x570

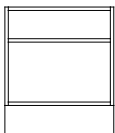

SDÖ60
605x704x570

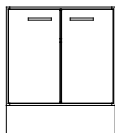

SDS60
605x704x570

Max 30 kg/
drawer

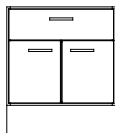

SD60/1L
605x704x570

Max 30 kg/
drawer

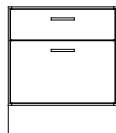

SD60/2L-30
605x704x570

Max 30 kg/
drawer

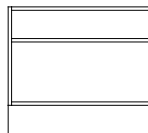

SDÖ80
800x704x570

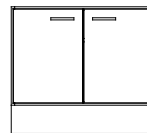

SDS80
800x704x570

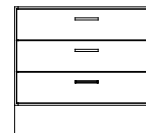

SD80/3L
800x704x570

Max 30 kg/
drawer

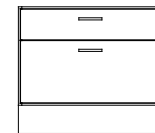

SD80/2L-30
800x704x570

Width 605 mm, Height 704 mm, Depth 570 mm

Name	White	NCS	Beech	Birch	Oak
SD60/3L	821721	829721L	823721	825721	827721
SDÖ60	821722	829722L	823722	825722	827722
SDS60	821724	829724L	823724	825724	827724
SD60/1L	821723	829723L	823723	825723	827723
SD60/2L-30	821725	829725L	823725	825725	827725

Width 800 mm, Height 704 mm, Depth 570 mm

Name	White	NCS	Beech	Birch	Oak
SDÖ80	821522	829522L	823522	825522	827522
SDS80	821524	829524L	823524	825524	827524
SD80/3L	821525	829525L	823525	825525	827525
SD80/2L-30	821526	829526L	823526	825526	827526

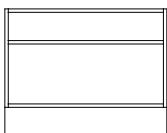

SDÖ90
900x704x570

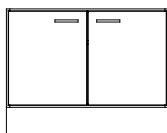

SDS90
900x704x570

Width 900 mm, Height 704 mm, Depth 570 mm

Name	White	NCS	Beech	Birch	Oak
SDÖ90	821822	829822L	823822	825822	827822
SDS90	821824	829824L	823824	825824	827824



Adjustable legs in stainless steel on page 103.



Make your printer cabinet mobile. Wheel sets can be found on page 103.

Stainless steel handles are standard. If you'd prefer black or white, please let us know when ordering. Legs, wheels and drawers can be found on page 102–103. Worktops on page 98.

Dimensions: Width x Height x Depth (height incl. plinth). **Frame:** 19 mm. **Front:** 16 mm. **Leg stand:** Height 300 mm. NCS refers to product lacquered in one optional NCS color.

CombiLine

Work station

Flexible piece of furniture with great varieties and storage from both sides where one side has drawers that can withstand up to a 50 kg load with full extension and soft closing. Standing on a sturdy white powder coated steel frame, height 300 mm. Frame and fronts in white. Stainless steel handles as standard, worktops in white* or anthracite**. If you would like black or white handles, please note this on your order.

Specifications →

CombiLine Work station

Width 1680 mm, Height 1046 mm, Depth 1180 mm (2 + 2 pairs of doors)

Name	Material/color	Art no
Work station 80x4, doors/doors	Frame + front white, work top F1040*	820310
Work station 80x4, doors/doors	Frame + front white, work top F2297**	820311
Work station 80x4, doors/doors	Frame + front white, work top F1040*, front any NCS	820312

Width 2480 mm, Height 1046 mm, Depth 1180 mm (3 + 3 pairs of doors)

Name	Material/color	Art no
Work station 80x6, doors/doors	Frame + front white, work top F1040*	820313
Work station 80x6, doors/doors	Frame + front white, work top F2297**	820314
Work station 80x6, doors/doors	Frame + front white, work top F1040*, front any NCS	820315

Width 1680 mm, Height 1046 mm, Depth 1180 mm (2 pairs of doors + 4 drawers)

Name	Material/color	Art no
Work station 80x4, doors/drawers	Frame + front white, work top F1040*	820200
Work station 80x4, doors/drawers	Frame + front white, work top F2297**	820201
Work station 80x4, doors/drawers	Frame + front white, work top F1040*, front any NCS	820202

Width 2480 mm, Height 1046 mm, Depth 1180 mm (3 pairs of doors + 6 drawers)

Name	Material/color	Art no
Work station 80x6, doors/drawers	Frame + front white, work top F1040*	820203
Work station 80x6, doors/drawers	Frame + front white, work top F2297**	820204
Work station 80x6, doors/drawers	Frame + front white, work top F1040*, front any NCS	820205

* High pressure laminate Formica F1040, white. ** High pressure laminate Formica F2297, anthracite.



Work station 80x6 doors/drawers, rear view (Art. no.820204).



Work station 80x6 doors/drawers, front view (Art. no.820204).



Work station 80x4 doors/drawers, rear view (Art. no. 820201).



Work station 80x4 doors/drawers, front view (Art. no. 820201).

Dimensions: Width x Height x Depth (height incl. plinth). **Frame:** 19 mm. **Front:** 16 mm. **Plinth:** 157 mm.
NCS refers to product lacquered in one optional NCS color.

CombiLine

Copy station

Ready combined stations consisting of wall cupboards, mail shelves and cabinets. Select the station that suits you best.

Frames and fronts in white, worktops in F2297*. Stainless steel handles are standard. You can also get the handles in black or white. All low drawers can hold up to 30 kg. Drawers that can hold up to 50 kg are available upon request. Worktops longer than 2440 mm are delivered in two parts. Whole worktops are available at additional cost.

Specifications →

Copy station – Ready combinations

Name	Size	Art no
Copy station 1	2800x903x600	820400
Copy station 2	2380x903x600	820401
Copy station 3	1420x903x600	820402
Copy station 4	1220x903x600	820403



Copy station 1. Ready combination, consisting of cabinets, wall cupboards and mail shelves. Length 2800 mm.



Copy station 2. Ready combination consisting of cabinets, wall cupboards, mail shelves and recycling unit. Length 2380 mm. Recycling container not incl., available as an accessory.



Copy station 3. Ready combination consisting of cabinets and wall cupboards. Length 1420 mm. Complete the station with a recycling unit, see page 95.



Copy station 4. Ready combination consisting of cabinets, wall cupboards and mail shelves. Length 1220 mm.

* High pressure laminate Formica F2297, anthracite.

Dimensions: Width x Height x Depth. **Frame:** 19 mm. **Front:** 16 mm.

Mail shelf: Acrylic. **Plinth height:** 157 mm.

Mail shelves are mounted c/c 96 mm as standard. Mounting strip is included in all wall-mounted products. NCS refers to product lacquered in one optional NCS color.

CombiLine

Mail sorting

Complete module series for mail sorting. Adaptable according to need and taste – the height or width of the floor or wall with any number of mail shelves.

Mail slots with reach-through capability makes it possible to manage mail from both sides. Mail sorting can be supplemented with more mail shelves for subdivision c/c 64 mm or c/c 32 mm. Standard is c/c 96 mm.

Specifications →



Pull-out shelves are incl. in most of our floor standing mail sorting units. This helps promote ergonomic working conditions.



The sliding mail shelves have integrated label holders.

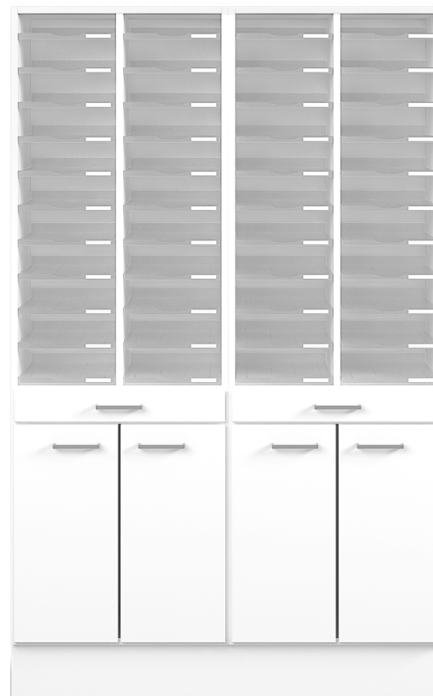

Two HPS2/22 side by side.

CombiLine Mail sorting Cabinet & Wall, sliding acrylic shelves

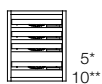

L1/4
310x371x370



L2/8
605x371x370

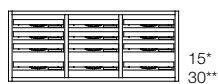

L3/12
900x371x370

* Number of shelves when mounting c/c 64 mm.
** Number of shelves when mounting c/c 32 mm.

Height 371 mm, Depth 370 mm

Name	White	NCS	Beech	Birch	Oak
L1/4	851115	859115L	853115	855115	857115
L2/8	851111	859111L	853111	855111	857111
L3/12	851112	859112L	853112	855112	857112

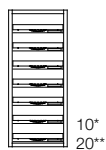

H1/7
310x723x370



H2/14
605x723x370



H3/21
900x723x370

Height 723 mm, Depth 370 mm

Name	White	NCS	Beech	Birch	Oak
H1/7	851116	859116L	853116	855116	857116
H2/14	851113	859113L	853113	855113	857113
H3/21	851114	859114L	853114	855114	857114

CombiLine Mail sorting – reach-through Sliding acrylic shelves

Name	White	NCS	Beech	Birch	Oak
L1/4G	851115G	859115GL	853115G	855115G	857115G
L2/8G	851111G	859111GL	853111G	855111G	857111G
L3/12G	851112G	859112GL	853112G	855112G	857112G

Name	White	NCS	Beech	Birch	Oak
H1/7G	851116G	859116GL	853116G	855116G	857116G
H2/14G	851113G	859113GL	853113G	855113G	857113G
H3/21G	851114G	859114GL	853114G	855114G	857114G

Dimensions: Width x Height x Depth. **Frame:** 19 mm. **Front:** 16 mm.

Mail shelf: Acrylic. **Plinth height:** 157 mm.

Mail shelves are mounted c/c 96 mm as standard. Mounting strip is included in all wall-mounted products.

NCS refers to product lacquered in one optional NCS color.

CombiLine Mail sorting Wall, sliding acrylic shelves

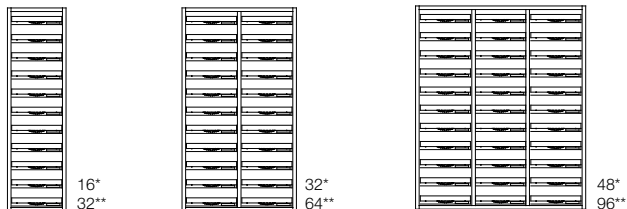

EH1/11
310x1075x370

EH2/22
605x1075x370

EH3/33
900x1075x370

* Number of shelves when mounting c/c 64 mm.

** Number of shelves when mounting c/c 32 mm.

Height 1075 mm, Depth 370 mm (Sliding acrylic shelves)

Name	White	NCS	Beech	Birch	Oak
EH1/11	851123	859123L	853123	855123	857123
EH2/22	851121	859121L	853121	855121	857121
EH3/33	851122	859122L	853122	855122	857122

CombiLine Mail sorting Wall, doors in steel

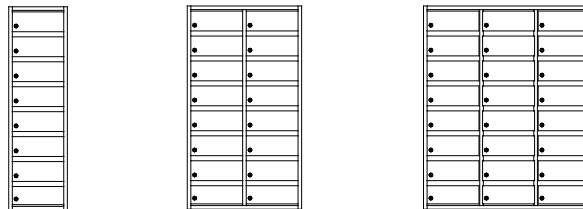

PL1/8
310x1075x370

PL2/16
605x1075x370

PL3/24
900x1075x370

Height 1075 mm, Depth 370 mm (Shelves in same material as frame)

Name	White	NCS	Beech	Birch	Oak
PL1/8	851511	859511L	853511	855511	857511
PL2/16	851521	859521L	853521	855521	857521
PL3/24	851531	859531L	853531	855531	857531

Mail doors in white lacquered steel. Incl. locks with two keys.

Mail sorting – reach-through Sliding acrylic shelves

Name	White	NCS	Beech	Birch	Oak
EH1/11G	851123G	859123GL	853123G	855123G	857123G
EH2/22G	851121G	859121GL	853121G	855121G	857121G
EH3/33G	851122G	859122GL	853122G	855122G	857122G

Accessories

Name	Art no
Master key	840913
Mail shelf, acrylic, incl. mounting strips	810919

CombiLine Mail sorting Floor, doors in steel

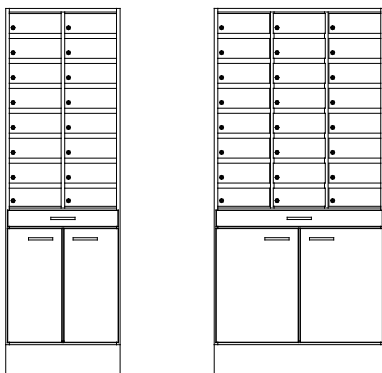

HPL2/16
605x1936x370

HPL3/24
900x1936x370

Mail sorting floor is available with a reach through function. Contact TreCe for more information.

Mail doors in white lacquered steel. Incl. locks with two keys.

Height 1936 mm, Depth 370 mm (Shelves in same material as frame)

Name	White	NCS	Beech	Birch	Oak
HPL2/16	851541	859541L	853541	855541	857541
HPL3/24	851551	859551L	853551	855551	857551

Dimensions: Width x Height x Depth. **Frame:** 19 mm. **Front:** 16 mm.

Mail shelf: Acrylic. **Plinth height:** 157 mm.

Mail shelves are mounted c/c 96 mm as standard. Mounting strip is included in all wall-mounted products.

NCS refers to product lacquered in one optional NCS color.

CombiLine Mail sorting Floor, sliding acrylic shelves



* Number of shelves when mounting c/c 64 mm.

** Number of shelves when mounting c/c 32 mm.

Height 1584 mm, Depth 370 mm

Name	White	NCS	Beech	Birch	Oak
LPS2/14	851224	859224L	853224	855224	857224

Height 1584 mm, Depth 370 mm

Name	White	NCS	Beech	Birch	Oak
LPS3/21	851324	859324L	853324	855324	857324

Height 1936 mm, Depth 370 mm

Name	White	NCS	Beech	Birch	Oak
HPS2/14	851214	859214L	853214	855214	857214
HPS2/22	851216	859216L	853216	855216	857216

Height 1936 mm, Depth 370 mm

Name	White	NCS	Beech	Birch	Oak
HPS3/21	851314	859314L	853314	855314	857314
HPS3/33	851316	859316L	853316	855316	857316

CombiLine Mail sorting Floor, sliding acrylic shelves

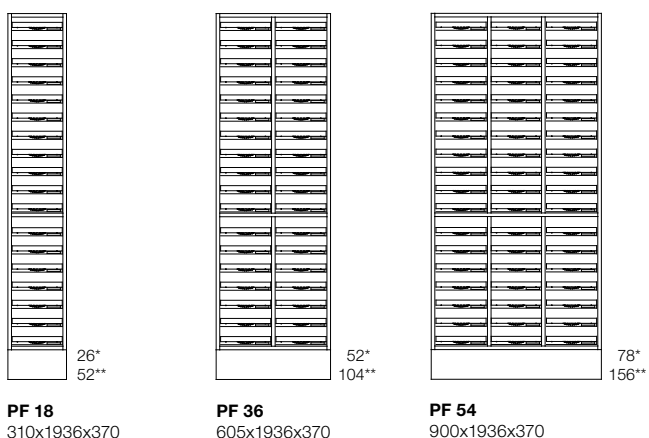

* Number of shelves when mounting c/c 64 mm.

** Number of shelves when mounting c/c 32 mm.

Height 1936 mm, Depth 370 mm

Name	White	NCS	Beech	Birch	Oak
PF18	851411	859411L	853411	855411	857411
PF36	851421	859421L	853421	855421	857421
PF54	851431	859431L	853431	855431	857431

Height 1584 mm, Depth 370 mm

Name	White	NCS	Beech	Birch	Oak
PF14	851412	859412L	853412	855412	857412
PF28	851422	859422L	853422	855422	857422
PF42	851432	859432L	853432	855432	857432

Dimensions: Width x Height x Depth (height incl. plinth). **Frame:** 19 mm. **Front:** 16 mm.
Plinth: 157 mm with adjustable legs.

Mail

Post storage

Mail is available in white and can accommodate hanging folders in folio format, has a mail slot for out-going mail, a waste unit and a drawer for office supplies. Custom designed symbols and a 60-liter container is included.

All drawers withstand 50 kg, 100% extension and are soft closing. Frame in white laminate and fronts in white UV lacquer (NCS S 0500-N).

Plinth and worktops in laminate from Formica, ash or gray. Inlet in white powder coated steel. Symbols and 60-liter container are included.

Mail can hold postage for up to 200 people.



Storage suitable for envelopes, etc.



Drawer adapted to the Mail's plastic tray.



Drawers for hanging folders in folio format, 365x240 mm, c/c 390 mm. Folders are available as accessories.



Door with inlet, 60-liter container incl.

Mail Post storage

1840x1080x600

Name	Size	Art no
Mail white/gray	White with top+plinth in gray (F2297)	751010
Mail white/ash	White with top+plinth in ash (F1004)	751020

Accessories

Name	Size	Art no
Mail hanging folders	25, Esselte, format foolscap.	751090

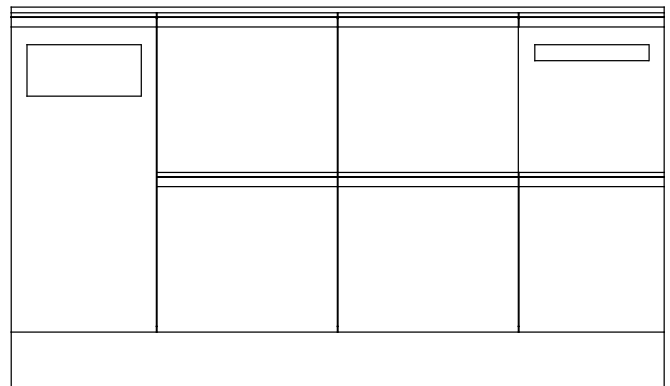

Contact TreCe if you would like a different combination of Mail.

Dimensions: Width x Height x Depth.

Soft

Media unit

Storage unit in white pigmented ash veneer or white lacquered MDF. All units are prepared for media storage, with outlets for cables and ventilation. Soft is also available as a wall module.

Choose between white pigmented ash veneer or white lacquered MDF (0500 N). Both options of Soft have a white ash melamine structure (Egger W1000 ST22) on the inside.



Soft has a small hidden drawer in the drawer for a plain outside and a functional inside. Distance between door and frame for ventilation.

Soft Media unit, white pigmented ash veneer

Name	Size	Art no
Soft 2x60, door/door	1246x466x497	502002
Soft 2x60, door/drawer	1246x466x497	502012
Soft 3x60, 2x doors/1x drawer	1851x466x497	503012
Soft 4x60, 3x doors/1x drawer	2456x466x497	504012

Please note the requested number of right and left-hung doors in your order.

Soft Media unit, white lacquered MDF

Name	Size	Art no
Soft 2x60, door/door	1246x466x497	502001
Soft 2x60, door/drawer	1246x466x497	502011
Soft 3x60, 2x doors/1x drawer	1851x466x497	503011
Soft 4x60, 3x doors/1x drawer	2456x466x497	504011

Please note the requested number of right and left-hung doors in your order.

Soft 2x60 + Leg stand 2

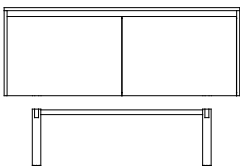

Soft 3x60 + Leg stand 3

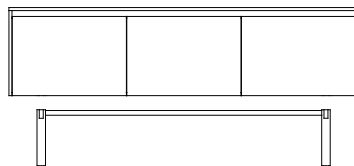

Soft 4x60 + Leg stand 4

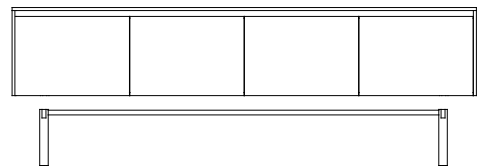

Soft leg stand, white pigmented solid ash

Name	Size	Art no
Soft leg stand 2 massive ash	942x300x376	505002
Soft leg stand 3 massive ash	1547x300x376	505003
Soft leg stand 4 massive ash	2152x300x376	505004

Soft mounting strip, white pigmented ash veneer

Name	Size	Art no
Soft wall strip 2	1200x80x16	506002
Soft wall strip 3	1805x80x16	506003
Soft wall strip 4	2410x80x16	506004

Dimensions: Width x Height x Depth.

Sail

Clothes hanger

Clothes stand for several types of hanging traditionally on the knobs, hanging over the rods or with a coat hanger.

Sail is available as floor standing or as a wall mounted module, with matching wall mounts.

Sail Floor comes in two parts, Sail Wall is delivered as one unit with matching wall mounts. Both are delivered in a flat package and are easy to assemble.

- Laser cut-out from one whole piece
- No welding joints
- Powder-coated steel
- 11 selected RAL colors
- Accented knobs in brass



Sail clothes stand

Name	Size	RAL 9010	RAL 7035	RAL 7016	RAL 5014	RAL 5008	RAL 6033	RAL 6021	RAL 6020	RAL 1021	RAL 3022	RAL 3005
		Pure white	Light gray	Anthracite	Pigeon blue	Gray blue	Mint turq.	Pale green	Ch. green	Yellow	Salmon pink	Wine red
Sail, Floor	777x1812x822	371005	371012	371003	371004	371007	371010	371001	371006	371011	371008	371009
Sail, Wall	689x1532x158	373005	373012	373003	373004	373007	373010	373001	373006	373011	373008	373009

Sail Colors

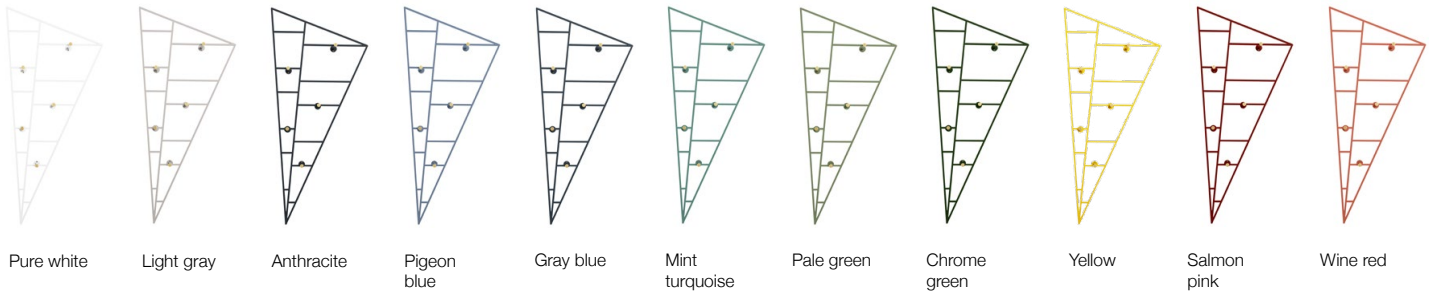

Note that the color reproduction in the catalog may differ from physical products.

Frame: Powder-coated steel plate. **Lid:** Powder-coated aluminum.

Shaft, wall mount and footplate: Powder-coated steel plate.

Birdie

Recycling

Birdie is made in two sizes and holds 43 L (Birdie 500) and 63 L (Birdie 750). Both have soft closing lids and inlets in stable quality plastic.

Sustainability & Material

Frame in powder coated steel made in Sweden, consists of 20% recycled materials. The steel is 100% recyclable. The powder coating is a good environmental choice as no solvents are used.

The lid inlet is in plastic and marked according to ISO 11469 for recycling. It can easily be removed for cleaning and is dishwasher safe. The lid in the closed position prevents odor and works in an upright position as a splash protection. Birdies thought through design makes it easy to empty.



How to order your Birdie:

Always start from the left and repeat steps 1–2 for each new unit. Finish each combination by selecting step 3. (For Birdie wall – skip step 3).

- 1 Choose unit (size, color, floor or wall).
- 2 Choose a symbol.
- 3 Choose a footplate.



Wall-mounted Birdie.



Lid inlet in plastic.

Accessories

Name		Color	Art no
Birdie plastic bag 85L		Transparent	345201
Birdie moisture protection	Ø 35 mm, H: 25 mm	Transparent	350001

Birdie Colors



Frame: Powder-coated steel plate. **Lid:** Powder-coated aluminum.
Shaft, wall mount and footplate: Powder-coated steel plate.

Birdie Floor, 500 (43 liter) and 750 (63 liter), incl. shaft

Color	Birdie 500	Birdie 750
RAL 9010 Pure white	350107	350207
RAL 7035 Light gray	350105	350205
RAL 7016 Anthracite	350108	350208
RAL 5014 Pigeon blue	350111	350211
RAL 5008 Gray blue	350112	350212
RAL 6033 Mint turquoise	350115	350215
RAL 6021 Pale green	350109	350209
RAL 6020 Chrome green	350110	350210
RAL 1021 Yellow	350101	350201
RAL 3022 Salmon pink	350113	350213
RAL 3005 Wine red	350114	350214

Any RAL color at additional cost, contact TreCe.

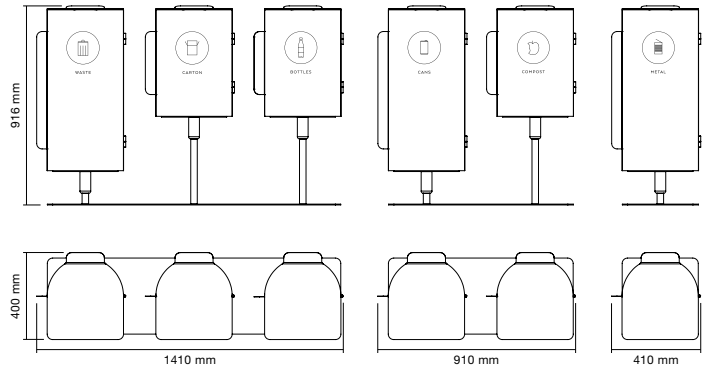

Birdie Wall, 500 (43 liter) and 750 (63 liter) incl. wall mount

Color	Birdie 500	Birdie 750
RAL 9010 Pure white	351307	351407
RAL 7035 Light gray	351305	351405
RAL 7016 Anthracite	351308	351408
RAL 5014 Pigeon blue	351311	351411
RAL 5008 Gray blue	351312	351412
RAL 6033 Mint turquoise	351315	351415
RAL 6021 Pale green	351309	351409
RAL 6020 Chrome green	351310	351410
RAL 1021 Yellow	351301	351401
RAL 3022 Salmon pink	351313	351413
RAL 3005 Wine red	351314	351414

Any RAL color at additional cost, contact TreCe.

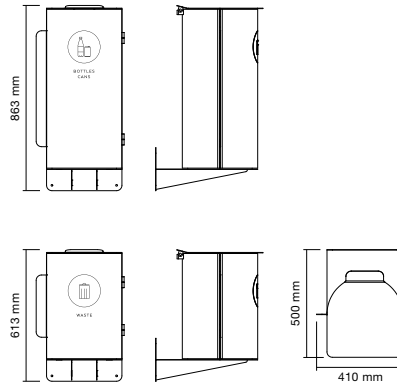

Birdie Symbol Ø 150 mm, white or anthracite

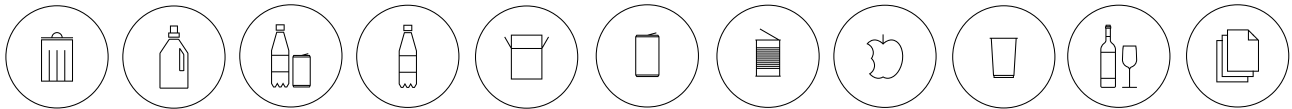

WASTE

PLASTIC

BOTTLES
CANS

BOTTLES

CARTON

CANS

METAL

COMPOST

PAPER CUPS

GLASS

PAPER

Color	WASTE	PLASTIC	BOTTLES CANS	BOTTLES	CARTON	CANS	METAL	COMPOST	PAPER CUPS	GLASS	PAPER
White	355001	355002	355003	355004	355005	355006	355007	355008	355009	355010	355011
Anthracite	355101	355102	355103	355104	355105	355106	355107	355108	355109	355110	355111

Contact TreCe if you would like other symbols or text in other languages.

Birdie Footplate 1, 2 and 3

Color	Footpl. 1	Footpl. 2	Footpl. 3
RAL 9010 Pure white	353007	353107	353207
RAL 7035 Light gray	353005	353105	353205
RAL 7016 Anthracite	353008	353108	353208
RAL 5014 Pigeon blue	353011	353111	353211
RAL 5008 Gray blue	353012	353112	353212
RAL 6033 Mint turquoise	353015	353115	353215

Color	Footpl. 1	Footpl. 2	Footpl. 3
RAL 6021 Pale green	353009	353109	353209
RAL 6020 Chrome green	353010	353110	353210
RAL 1021 Yellow	353001	353101	353201
RAL 3022 Salmon pink	353013	353113	353213
RAL 3005 Wine red	353014	353114	353214

Dimensions: Width x Height (incl. wheels) x Depth.

Cloud Recycling

Cloud is equipped with doors for easy emptying. Doors and backs are equipped with specially designed recycling symbols, and with the possibility to choose color and labeling, Cloud can be adapted to different types of environments and needs. The high quality wheels are swivel and lockable.

White pull-out bag holders are included in the frame. Load capacity per wheel: 80 kg. Black wheels with rubber surface, height: 100 mm. Two of the wheels have a brake. Inlet from two directions, front (door) and rear (back). Fitted lip on the inside of doors lead waste into the bag. Back is fixed. Designed for 85–125 liter bags.

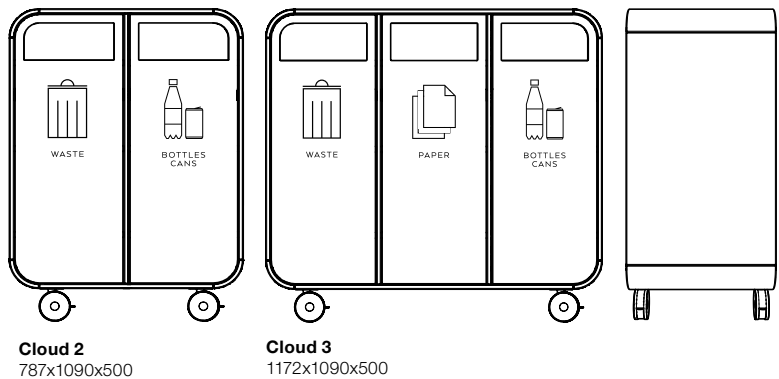

Cloud Colors Frames MFC laminate



Light gray
(U12188)



Anthracite
(U12011)

Cloud Colors Frames NCS + RAL



Pure white



Light gray



Anthracite



Pigeon blue



Gray blue



Mint turquoise



Pale green



Chrome green



Yellow



Salmon pink



Wine red

Dimensions: Width x Height (incl. wheels) x Depth.

This is how you order your Cloud:

- 1 Choose the frame (laminate or lacquered MDF).
- 2 Choose doors (backs are included) Cloud 2 – 1. left & 1. right door
Cloud 3 – 1. left, 1. middle & 1. right door.
- 3 Choose 2. alt. 3. symbols depending on frame (same symbol selected for the door is also mounted on the opposite side (back).
- 4 Add a rubber mat and moisture protection bottom if necessary.



Cloud Frame, MFC laminate, thickness 16 mm

Name	Light gray (U12188)	Anthracite (U12011)
Cloud 2 Frame laminate	480401	480402
Cloud 3 Frame* laminate	480301	480302

*Cloud 3 has an extra wheel, 5 in total.

Cloud Frame, lacquered MDF, thickness 16 mm

Name	NCS RAL 9010 Pure white	NCS RAL 7035 Light gray	NCS RAL 7016 Anthracite	NCS RAL 5014 Pigeon blue	NCS RAL 5008 Gray blue	NCS RAL 6033 Mint turq.	NCS RAL 6021 Pale green	NCS RAL 6020 Ch. green	NCS RAL 1021 Yellow	NCS RAL 3022 Salmon pink	NCS RAL 3005 Wine red
Cloud 2 Frame	480203	480202	480204	480207	480208	480211	480205	480206	480201	480209	480210
Cloud 3 Frame*	480103	480102	480104	480107	480108	480111	480105	480106	480101	480109	480110

*Cloud 3 has an extra wheel, 5 in total.

Cloud Doors, powder-coated steel, thickness 3 mm (back included)

Name	RAL 9010 Pure white	RAL 7035 Light gray	RAL 7016 Anthracite	RAL 5014 Pigeon blue	RAL 5008 Gray blue	RAL 6033 Mint turq.	RAL 6021 Pale green	RAL 6020 Ch. green	RAL 1021 Yellow	RAL 3022 Salmon pink	RAL 3005 Wine red
Cloud Door left	481001	481002	481003	481004	481005	481006	481007	481008	481009	481010	481011
Cloud Door middle	481101	481102	481103	481104	481105	481106	481107	481108	481109	481110	481111
Cloud Door right	481201	481202	481203	481204	481205	481206	481207	481208	481209	481210	481211

Cloud Symbol (2 pack, symbol for back included)

Color	WASTE	PLASTIC	BOTTLES CANS	BOTTLES	CARTON	METAL	PAPER
White	482001	482002	482003	482004	482005	482006	482008
Anthracite	482101	482102	482103	482104	482105	482106	482108

Accessories

Name	Art no
Cloud plastic bags 85 liter, 25 pcs.	483001
Cloud moisture protection	483002
Cloud rubber mat, black	483003

Contact TreCe if you would like other symbols or text in other languages.

Frame: Powder-coated steel plate.

Lid: Vacuum-foiled MDF with screen print.

Kite

Recycling

Designed for modularity in different constellations. Kite can be placed against a wall or as a free-standing accent in a room.

The many possible combination challenges the imagination and inspires creativity. Lids come in 8 different designs with screen-printed symbols for different types of waste. Kite holds 70 liters, suitable for standard bags of 85–125 liters.

Sustainability & Material

The lid's MDF meets E1 requirements for formaldehyde. MDF from certified forestry. The frame in powder-coated steel plate is manufactured in Sweden and consists of 20% of recycled material. The steel is 100% recyclable. The powder coating of the frame is a good environmental choice as no solvents are required.



Kite Colors



Kite Frame

Width 500 mm, Height 700 mm, Depth 492 mm

Color	Art no
RAL 9010 Pure white	881097
RAL 7035 Light gray	881096
RAL 7016 Anthracite	881098
RAL 5014 Pigeon blue	881090
RAL 5008 Gray blue	881091
RAL 6033 Mint turquoise	881094
RAL 6021 Pale green	881088
RAL 6020 Chrome green	881089
RAL 1021 Yellow	881095
RAL 3022 Salmon pink	881092
RAL 3005 Wine red	881093
RAW, clear powder-coated steel sheet, matte, gloss 5	881087

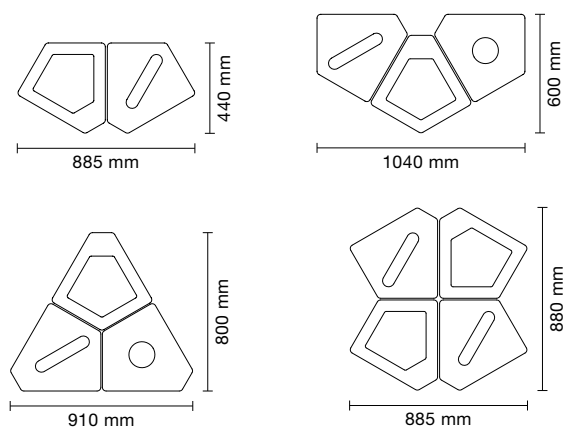

Any RAL color at additional cost, contact TreCe.

Frame: Powder-coated steel plate.

Lid: Vacuum-foiled MDF with screen print.

Kite lid, white or anthracite, vacuum-foiled MDF, shape design with screen-printed symbol in gray

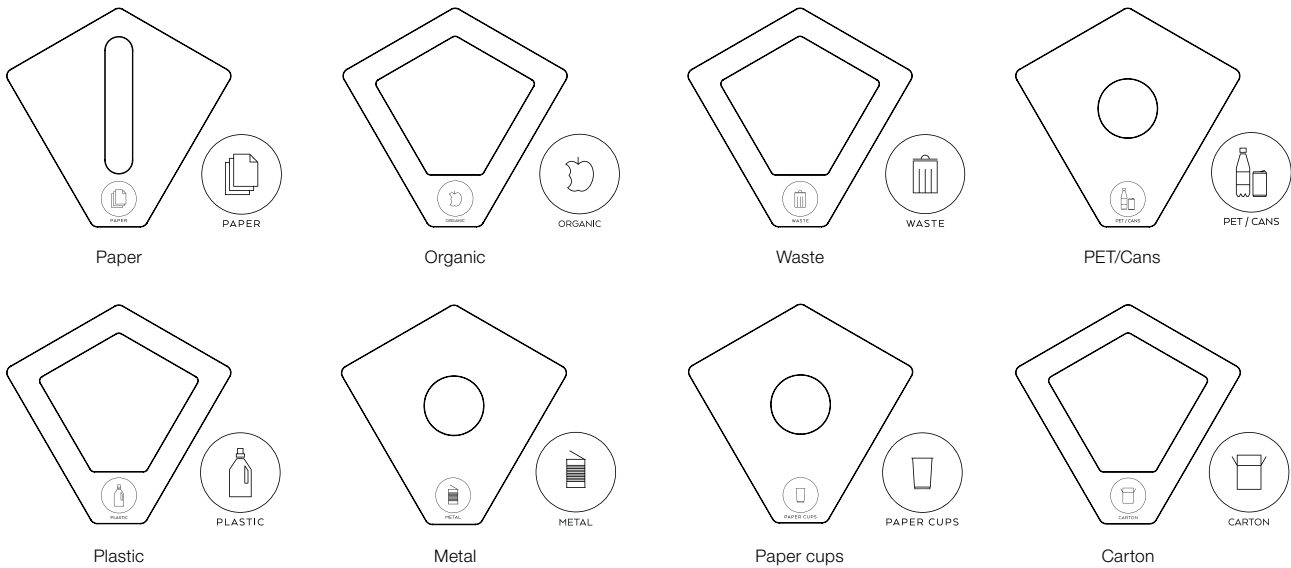

Contact TreCe if you would like other symbols or text in other languages.

Name	Anthracite	White
Kite lid Paper	882115	882111
Kite lid Organic	882116	882112
Kite lid Waste	882117	882113
Kite lid PET/Cans	882118	882114
Kite lid Plastic	882148	882147
Kite lid Metal	882150	882149
Kite lid Paper cups	882142	882141
Kite lid Carton	882145	882144

Accessories

Name		Transparent
Kite plastic bags	85 liter, 25 pcs.	881159
Kite moisture protection	Height 350 mm	881180

Name	Fits Kite-lid	Anthracite	White
Kite lid insert with knob	Organic, Waste, Plastic, Carton	881182	881181



Kite lid insert in lacquered MDF, NCS S 0500-N, with white knob.



Kite moisture protection base for easy cleaning. Recommended for wet fractions like waste, organics and bottles/cans.



Kite Raw

Frame: Powder-coated steel plate.

Lid: Vacuum-foiled MDF with screen print.

Kite mini

Recycling

Kite mini is intended for smaller spaces like under desks, hotel rooms or smaller conference rooms. There is also a wall mount for the Kite mini, which means that it can be placed on the wall. As single or in pairs to free floor space.

Sustainability & Material

The lid's MDF meets E1 requirements for formaldehyde. MDF from certified forestry. The frame in powder-coated steel plate is manufactured in Sweden and consists of 20% of recycled material. The steel is 100% recyclable.

The powder coating of the frame is a good environmental choice as no solvents are required. Base in 100% recycled ABS plastic, marked for recycling according to ISO 11469. In line with our environmental strategy, Kite mini is delivered unassembled.

- No fittings
- No tools
- Easy to assemble



Kite mini Colors



Pure white

Light gray

Anthracite

Pigeon blue

Gray blue

Mint turquoise

Pale green

Chrome green

Yellow

Salmon pink

Wine red

Kite mini Floor, Frame 10L

Width 250 mm, Height 355 mm, Depth 245 mm

Color	Art no
RAL 9010 Pure white	882097
RAL 7035 Light gray	882096
RAL 7016 Anthracite	882098
RAL 5014 Pigeon blue	882090
RAL 5008 Gray blue	882091
RAL 6033 Mint turquoise	882094
RAL 6021 Pale green	882088
RAL 6020 Chrome green	882089
RAL 1021 Yellow	882095
RAL 3022 Salmon pink	882092
RAL 3005 Wine red	882093

Frame: Powder-coated steel plate.

Lid: Vacuum-foiled MDF with screen print.

Kite mini Wall, Frame 10L, wall mount, right or left

Width 250 mm, Height 355 mm, Depth 245 mm

Color	Kite Mini wall right	Kite Mini wall left
RAL 9010 Pure white	883097	884097
RAL 7035 Light gray	883096	884096
RAL 7016 Anthracite	883098	884098
RAL 5014 Pigeon blue	883090	884090
RAL 5008 Gray blue	883091	884091
RAL 6033 Mint turquoise	883094	884094
RAL 6021 Pale green	883088	884088
RAL 6020 Chrome green	883089	884089
RAL 1021 Yellow	883095	884095
RAL 3022 Salmon pink	883092	884092
RAL 3005 Wine red	883093	884093



Wall mount included with Kite mini wall.

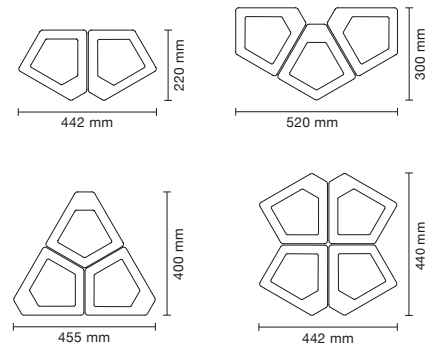

Kite mini Lid, white or anthracite, vacuum-foiled MDF, screen-printed symbol

Name	Anthracite	White
Kite mini lid Paper	882215	882211
Kite mini lid Organic	882216	882212
Kite mini lid Waste	882217	882213
Kite mini lid PET/Cans	882218	882214
Kite mini lid Metal	882245	882244
Kite mini lid Plastic	882248	882247

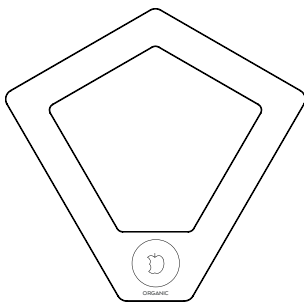

Frame: Powder-coated steel plate.
Lid: 1.5 mm powder-coated steel.

Hold

Recycling

TreCe, together with Tengbom architects, have developed the recycling bin Hold. A collaboration that started with Tengbom seeing a need for a different and functional recycling bin that could meet the needs of smaller spaces. Conference rooms, hotel rooms, smaller meeting rooms, etc. TreCe was contacted and the result was Hold.

A small and functional bin with a lid that is available in 7 different profiles. There is also a wall mount for Hold, which means that it can be placed on the wall.

Sustainability & Material

Frame in powder coated steel plate made in Sweden and consists of 20% recycled materials, The steel plate is 100% recyclable. The powder coating is a good environmental choice as no solvents are used. Container bin in 100% recycled plastic. The container bins are dishwasher safe.

How to order Hold:

- 1 Choose frame (floor or wall) & color
- 2 Choose lid & color
- 3 Choose container bin or a bag holder



Wall mount included.



Hold Floor

Width 340 mm, Height 300 mm, Depth 230 mm

Color	Art no
RAL 9010 Pure white	470103
RAL 7035 Light gray	470102
RAL 7016 Anthracite	470104
RAL 5014 Pigeon blue	470107
RAL 5008 Gray blue	470108
RAL 6033 Mint turquoise	470111
RAL 6021 Pale green	470105
RAL 6020 Chrome green	470106
RAL 1021 Yellow	470101
RAL 3022 Salmon pink	470109
RAL 3005 Wine red	470110

Lid and container bins. See page 91.

Hold Wall incl. wall mount

Color	Art no
RAL 9010 Pure white	470203
RAL 7035 Light gray	470202
RAL 7016 Anthracite	470204
RAL 5014 Pigeon blue	470207
RAL 5008 Gray blue	470208
RAL 6033 Mint turquoise	470211
RAL 6021 Pale green	470205
RAL 6020 Chrome green	470206
RAL 1021 Yellow	470201
RAL 3022 Salmon pink	470209
RAL 3005 Wine red	470210

Hold Colors



Frame: Powder-coated steel plate.
Lid: 1.5 mm powder-coated steel.

Hold Lid

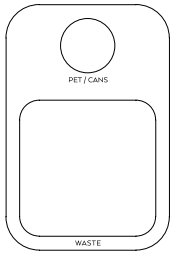

**Lid 1 – PET/Cans round inlet
Waste large inlet**

Color	Art no
RAL 9010 Pure white	470303
RAL 7035 Light gray	470302
RAL 7016 Anthracite	470304
RAL 5014 Pigeon blue	470307
RAL 5008 Gray blue	470308
RAL 6033 Mint turq.	470311
RAL 6021 Pale green	470305
RAL 6020 Ch. green	470306
RAL 1021 Yellow	470301
RAL 3022 Salmon pink	470309
RAL 3005 Wine red	470310

Containers:	Art no
1x Hold container small	471001
1x Hold container large	471002

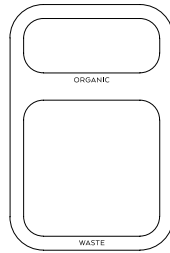

**Lid 2 – Organic small inlet
Waste large inlet**

Color	Art no
RAL 9010 Pure white	470403
RAL 7035 Light gray	470402
RAL 7016 Anthracite	470404
RAL 5014 Pigeon blue	470407
RAL 5008 Gray blue	470408
RAL 6033 Mint turq.	470411
RAL 6021 Pale green	470405
RAL 6020 Ch. green	470406
RAL 1021 Yellow	470401
RAL 3022 Salmon pink	470409
RAL 3005 Wine red	470410

Containers:	Art no
1x Hold container small	471001
1x Hold container large	471002

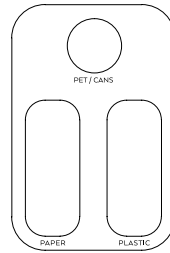

**Lid 3 – PET/Cans round inlet
Paper & Plastic small inlet**

Color	Art no
RAL 9010 Pure white	470503
RAL 7035 Light gray	470502
RAL 7016 Anthracite	470504
RAL 5014 Pigeon blue	470507
RAL 5008 Gray blue	470508
RAL 6033 Mint turq.	470511
RAL 6021 Pale green	470505
RAL 6020 Ch. green	470506
RAL 1021 Yellow	470501
RAL 3022 Salmon pink	470509
RAL 3005 Wine red	470510

Containers:	Art no
3x Hold container small	471001

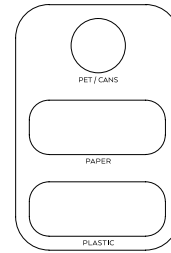

**Lid 4 – PET/Cans round inlet
Paper & Plastic small inlet**

Color	Art no
RAL 9010 Pure white	470603
RAL 7035 Light gray	470602
RAL 7016 Anthracite	470604
RAL 5014 Pigeon blue	470607
RAL 5008 Gray blue	470608
RAL 6033 Mint turq.	470611
RAL 6021 Pale green	470605
RAL 6020 Ch. green	470606
RAL 1021 Yellow	470601
RAL 3022 Salmon pink	470609
RAL 3005 Wine red	470610

Containers:	Art no
3x Hold container small	471001

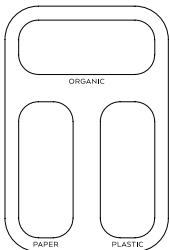

**Lid 5 – Organic, Paper & Plastic
small inlet**

Color	Art no
RAL 9010 Pure white	470703
RAL 7035 Light gray	470702
RAL 7016 Anthracite	470704
RAL 5014 Pigeon blue	470707
RAL 5008 Gray blue	470708
RAL 6033 Mint turq.	470711
RAL 6021 Pale green	470705
RAL 6020 Ch. green	470706
RAL 1021 Yellow	470701
RAL 3022 Salmon pink	470709
RAL 3005 Wine red	470710

Containers:	Art no
3x Hold container small	471001

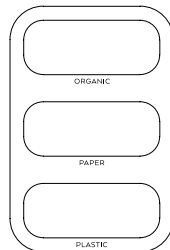

**Lid 6 – Organic, Paper & Plastic
small inlet**

Color	Art no
RAL 9010 Pure white	470803
RAL 7035 Light gray	470802
RAL 7016 Anthracite	470804
RAL 5014 Pigeon blue	470807
RAL 5008 Gray blue	470808
RAL 6033 Mint turq.	470811
RAL 6021 Pale green	470805
RAL 6020 Ch. green	470806
RAL 1021 Yellow	470801
RAL 3022 Salmon pink	470809
RAL 3005 Wine red	470810

Containers:	Art no
:3x Hold container small	471001

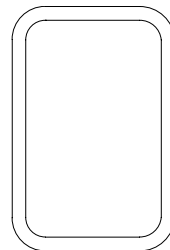

**Lid 7 – No symbol
large inlet (excl. bag holder*)**

Color	Art no
RAL 9010 Pure white	470903
RAL 7035 Light gray	470902
RAL 7016 Anthracite	470904
RAL 5014 Pigeon blue	470907
RAL 5008 Gray blue	470908
RAL 6033 Mint turq.	470911
RAL 6021 Pale green	470905
RAL 6020 Ch. green	470906
RAL 1021 Yellow	470901
RAL 3022 Salmon pink	470909
RAL 3005 Wine red	470910

Bag holder:	Art no
1x Hold bag holder for Lid 7	471010

Add Hold bag holder.

This only applies to Lid 7 due to the form of the inlet.

Containers/Bag holder

Name	Art no
Hold container small	471001
Hold container large	471002
Hold bag holder for Lid 7	471010

Bag holder for waste bags is neatly concealed by lid. Only for Lid 7.

Dimensions: Width x Height x Depth.
Bottom/Gable/Top: 22 mm lacquered MDF. **Door/Back:** 16 mm lacquered MDF.

Ridge

Recycling

Ridge, with its special expression, becomes a different and expressive feature in the modern office. It gives the impression of an interior detail, not just an recycling station. Ridge is available in two heights. The difference between Low and High is the slope of the upper part of the frame.

A very stable construction that is built of 22 mm MDF and lacquered in 11 standard colors. Stainless steel ramp for easier access of a 140 liter container is not only a practical detail, but also a design-prominent part.

Ridge can be ordered with different symbols depending on the purpose.

- Bag holder, door protection and loading ramp all in stainless steel
- Rubber mat included
- Adjustable feet
- Doors with aximate hinges, 135°



Doors with aximate hinges.



Bag holder in stainless steel.



Ramp in stainless steel.

Ridge Colors

Ramp in stainless steel.



Pure white



Light gray



Anthracite



Pigeon blue



Gray blue



Mint turquoise



Pale green



Chrome green



Yellow



Salmon pink



Wine red

Dimensions: Width x Height x Depth.

Bottom/Gable/Top: 22 mm lacquered MDF. **Door/Back:** 16 mm lacquered MDF.

Ridge – Low



140L container

Ridge – High



160L waste bag

Container/Bag holder

Name	Art no
Container 140 l	820941
Bag holder 125-160 l	820914

Ridge Frame Low

Width 600 mm, Height 1397 mm, Depth 650 mm

Name	NCS S0502-Y Pure white	NCS S1502-G Light gray	NCS RAL 7016 Anthracite	NCS RAL 5014 Pigeon blue	NCS RAL 5008 Gray blue	NCS RAL 6033 Mint turq.	NCS RAL 6021 Pale green	NCS RAL 6020 Ch. green	NCS RAL 1021 Yellow	NCS RAL 3022 Salmon pink	NCS RAL 3005 Wine red
Ridge Low bag	490103	490102	490104	490107	490108	490111	490105	490106	490101	490109	490110
Ridge Low container	490123	490122	490124	490127	490128	490131	490125	490126	490121	490129	490130

Ridge Frame High

Width 600 mm, Height 1521 mm, Depth 650 mm

Name	NCS S0502-Y Pure white	NCS S1502-G Light gray	NCS RAL 7016 Anthracite	NCS RAL 5014 Pigeon blue	NCS RAL 5008 Gray blue	NCS RAL 6033 Mint turq.	NCS RAL 6021 Pale green	NCS RAL 6020 Ch. green	NCS RAL 1021 Yellow	NCS RAL 3022 Salmon pink	NCS RAL 3005 Wine red
Ridge High bag	490203	490202	490204	490207	490208	490211	490205	490206	490201	490209	490210
Ridge High container	490223	490222	490224	490227	490228	490231	490225	490226	490221	490229	490230

Ridge Door – fits both Ridge Low and High

Name	NCS S0502-Y Pure white	NCS S1502-G Light gray	NCS RAL 7016 Anthracite	NCS RAL 5014 Pigeon blue	NCS RAL 5008 Gray blue	NCS RAL 6033 Mint turq.	NCS RAL 6021 Pale green	NCS RAL 6020 Ch. green	NCS RAL 1021 Yellow	NCS RAL 3022 Salmon pink	NCS RAL 3005 Wine red
Ridge door	490403	490402	490404	490407	490408	490411	490405	490406	490401	490409	490410

Ridge Symbol



WASTE



PLASTIC

BOTTLES
CANS

BOTTLES



CARTON



METAL



COMPOST



PAPER

Color	White	Anthracite	White	Anthracite	White	Anthracite	White	Anthracite	White	Anthracite	White	Anthracite
White	490501	490502	490503	490504	490505	490506	490507	490508	490501	490502	490503	490504
Anthracite	490511	490512	490513	490514	490515	490516	490517	490518	490511	490512	490513	490514

Dimensions: Width x Height x Depth.

Frame: 19 mm. **Front:** 16 mm. **Plinth front:** 75 mm. **Plinth:** 157 mm.

CombiLine

Recycling station

Ready combined recycling stations that cover the entire recycling for both large and small offices. Stainless steel handles are standard.

Frame and fronts in white, worktops in F2297**. Stainless steel handles are standard. If you'd prefer black or white, please let us know when ordering. All of the drawers have 100% expansion and withstand up to 35 kg. Complete with containers and symbols, see page 97.

Specifications →



Recycling station 1. Ready module (1020x1174x760 mm) with inlets. 350x350* mm in the worktop. The station is adapted for 190 L recycling containers/cardboard cart and 19 + 10 liter recycling containers. Recycling containers and cardboard cart are not incl. Stainless steel handles are included as standard.



Recycling station 3. Ready module (970x1174x600 mm) with inlets 250x250* mm in the worktop. The station is adapted for 140 L recycling containers/cardboard cart/bag holder and 19 + 10 L recycling containers. Containers, bag holders and cart are not incl. Stainless steel handles are included as standard.

*Worktop and inlets are included in the recycling station.

**High pressure laminate, Formica F2297, Anthracite.

Recycling station – ready combinations

Name	Size	Art no
Recycling station 1	1020x1174x760	820500
Recycling station 2	1670x1174x760	820501
Recycling station 3	970x1174x600	820502
Recycling station 4	970x1174x600	820503



Recycling station 2. Ready module (1670x1174x760 mm) with inlets. 350x350* mm in the worktop. The station is adapted for 190 L recycling containers/ cardboard cart and 19 + 10 liter recycling containers. Recycling containers and cardboard cart are not incl. Stainless steel handles are included as standard.



Recycling station 4. Ready module (970x1174x600 mm) with inlets 250x250* mm in the worktop. The station is adapted for 140 L recycling containers/cardboard cart and 10, 19 and 60 recycling containers. Recycling containers and trolley are not included. Stainless steel handles are included as standard.

Dimensions: Width x Height x Depth.

Frame: 19 mm. **Front:** 16 mm. **Plinth front:** 75 mm. **Plinth:** 157 mm.

NCS refers to product lacquered in one optional NCS color.

CombiLine

Recycling unit

Recycling units consisting of several modules which can easily be combined to cover the companies entire recycling. We offer everything from small recycling units with small containers placed in drawers, to larger stations with 240-liter containers.

Specifications →

Containers are also available separately in sizes 10-240 liters. Larger environmental units are always equipped with an access ramp in stainless steel.

CombiLine Recycling unit

Height 880 mm, Depth 370 mm

Name	White	NCS	Beech	Birch	Oak
MDL60/60L	821418	829418L	823418	825418	827418

Height 880/1057 mm, Depth 570 mm

Name	White	NCS	Beech	Birch	Oak
MD34	821416	829416L	823416	825416	827416
MD34/2L	821425	829425L	823425	825425	827425
MDL60/90L	821417	829417L	823417	825417	827417
MDH60/80L	821422	829422L	823422	825422	827422

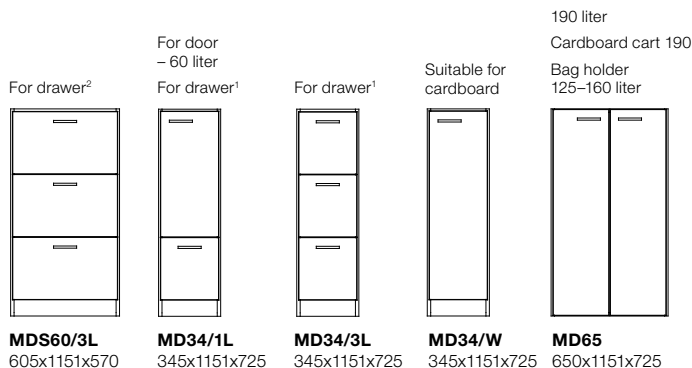
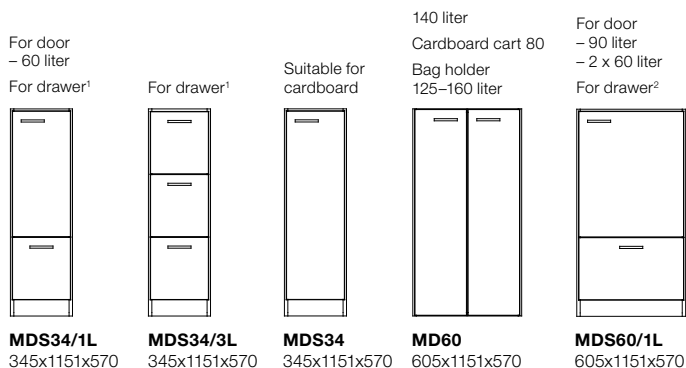
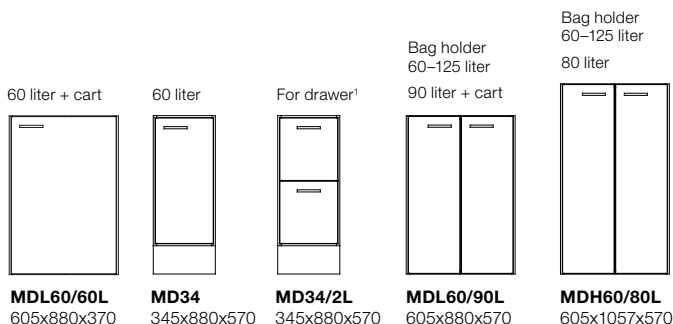

Height 1151 mm, Depth 570 mm

Name	White	NCS	Beech	Birch	Oak
MDS34/1L	821430	829430L	823430	825430	827430
MDS34/3L	821429	829429L	823429	825429	827429
MDS34	821431	829431L	823431	825431	827431
MD60	821428	829428L	823428	825428	827428
MDS60/1L	821433	829433L	823433	825433	827433
MDS60/3L	821434	829434L	823434	825434	827434

Height 1151 mm, Depth 790 mm

Name	White	NCS	Beech	Birch	Oak
MD70	821427	829427L	823427	825427	827427

Height 1151 mm, Depth 725 mm

Name	White	NCS	Beech	Birch	Oak
MD34/1L	821421	829421L	823421	825421	827421
MD34/3L	821423	829423L	823423	825423	827423
MD34/W	821432	829432L	823432	825432	827432
MD65	821424	829424L	823424	825424	827424

1.) For drawer any combination.
3 x 10 liter/drawer
1 x 10 liter + 1 x 19 liter/drawer
1 x 25 liter waste bag

2.) For drawer any combination.
2 x 10 liter + 2 x 19 liter
2 x 25 liter waste bag

240 liter

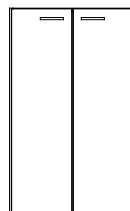

MD70
700x1151x790

Order worktops, inlets, containers and lids for your recycling unit. Containers for drawers are available in several sizes, adapted for different fractions. See pages 96–100.

CombiLine

Containers/bag holder



Recycling station with cardboard cart and recycling container on wheels.



Container 90 liter + cart.



Container 90 liter.



Container 2x19, 2x10 liter.



Waste bag 2x25 liter. Washable fabric with rubberized inside.



Waste bag 25 liter.

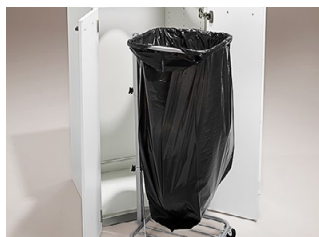

Bag holder, 60–125 liter.



Container 3x10 liter.



Container 19+10 liter.



Recycling station with container 60 liter.

Cardboard cart/Bag holder/Containers

Name	Fits	Size	Art no
Cardboard cart 80	MD60	480x990x480	820938
Cardboard cart 190	MD65	540x1035x620	820932
Bag holder, 60-125L	MDL60, MD60, MDH60	370x650-910x480	820949
Bag holder, 125-160L	MD60, MDH60, MD65	490x1000x460	820914
Container 240L	MD70	580x1070x731	820937
Container 190L	MD65	545x1000x690	820923
Container 140L	MD60	500x1042x543	820941
Container 80L	MDH60	446x962x536	820931
Container 90L*	MDS60/1L, DS60, MDL60	485x630x510	820926
Cart for 60L	Container 60 liter	455x150x225	820911
Cart for 90L	Container 90 liter	365x145x365	820915
Container 60L	MD34, MDS34/1L, MD34/1L	280x580x520	820929
Waste bag 25L	Drawer	250x230x430	820916
Container 19L	Drawer	230x283x330	820919
Container 10L	Drawer	255x283x165	820918



Cardboard cart



Bag holder, 60-125 liter



Bag holder, 125-160 liter



240 liter



190 liter



140 liter



80 liter



90 liter



60 liter



Cart for 60 + 90 liter



Waste bag 25 liter



19 liter



10 liter

Recycling symbols for worktops or fronts



Paper



Waste



Plastic



Organic



Energy saving lamps



Metal



PET-bottles/Cans



Paper mugs



Clear glass



Colored glass



Electronics



Batteries



Cardboard



Confidential waste

Aluminum sign with black symbol, fitted with double-sided adhesive tape. For drawers there are containers in several different sizes, adapted for different fractions.

Name	Size	Art no	Size	Art no
Symbol Paper	150x150	810951	75x75	810960
Symbol Waste	150x150	810953	75x75	810961
Symbol Plastic	150x150	810955	75x75	810962
Symbol Cardboard	150x150	810952	75x75	810972
Symbol Confidential waste	150x150	810954	75x75	810973
Symbol Organic			75x75	810963
Symbol Clear glass			75x75	810964

Name	Size	Art no
Symbol Colored glass	75x75	810965
Symbol Electronics	75x75	810966
Symbol Batteries	75x75	810967
Symbol Energy saving lamps	75x75	810968
Symbol Metal	75x75	810969
Symbol PET-bottles/Cans	75x75	810970
Symbol Paper mugs	75x75	810971



WASTE



PLASTIC



BOTTLES
CANS



BOTTLES



CARTON



CANS



METAL



COMPOST



PAPER CUPS



GLASS



PAPER

Contact TreCe if you would like foiled symbols on fronts. See also Cloud symbols on page 85.

Note that the color reproduction in the catalog may differ from physical products.

CombiLine

Worktops

High pressure laminate 23 mm standard work tops coated with high pressure laminate and 2 mm airtec-lipping*.

MFC laminate 22 mm standard worktops have an outer paper layer coated with an impregnated paper and a finish of aluminum particles for extra protection against wear. 2 mm matching airtec-lipping*.

Veneer Alternatively 22 mm clear lacquered beech, birch and oak veneered chipboard with 2 mm solid edging.

Airtec-lipping, also known as laser edging, provides an almost invisible joint between the worktop and edging strip. Thus provides a higher protection against water and heat. This new technology is glue-free, which results in a lower environmental impact.

Worktops High pressure laminate, Formica Collection Colors and Woods*



White
(F1040)

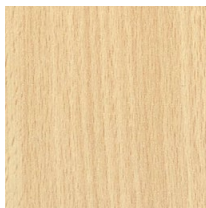

Beech
(F2726)



Birch
(F7555)



Oak
(F7603)

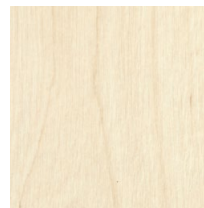

Ash
(F1004)



Light gray
(F7927)



Gray
(F7912)



Anthracite
(F2297)

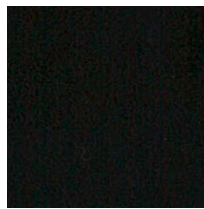

Black
(F2253)

*Airtec-lipping

Name	Color	Art no
Laminate - 390 mm depth	White F1040	821003
Laminate - 390 mm depth	Beech F2726	822003
Laminate - 390 mm depth	Birch F7555	824103
Laminate - 390 mm depth	Oak F7603	826003
Laminate - 390 mm depth	Ash F1004	828073
Laminate - 390 mm depth	Light gray F7927	828013
Laminate - 390 mm depth	Gray F7912	828003
Laminate - 390 mm depth	Anthracite F2297	828033
Laminate - 390 mm depth	Black F2253	828023
Laminate - 600 mm depth	White F1040	821001
Laminate - 600 mm depth	Beech F2726	822001
Laminate - 600 mm depth	Birch F7555	824101
Laminate - 600 mm depth	Oak F7603	826001
Laminate - 600 mm depth	Ash F1004	828071
Laminate - 600 mm depth	Light gray F7927	828011
Laminate - 600 mm depth	Gray F7912	828001
Laminate - 600 mm depth	Anthracite F2297	828031
Laminate - 600 mm depth	Black F2253	828021

Name	Color	Art no
Laminate - 760 mm depth	White F1040	821002
Laminate - 760 mm depth	Beech F2726	822002
Laminate - 760 mm depth	Birch F7555	824102
Laminate - 760 mm depth	Oak F7603	826002
Laminate - 760 mm depth	Ash F1004	828072
Laminate - 760 mm depth	Light gray F7927	828012
Laminate - 760 mm depth	Gray F7912	828002
Laminate - 760 mm depth	Anthracite F2297	828032
Laminate - 760 mm depth	Black F2253	828022
Laminate - 820 mm depth	White F1040	821004
Laminate - 820 mm depth	Beech F2726	822004
Laminate - 820 mm depth	Birch F7555	824104
Laminate - 820 mm depth	Oak F7603	826004
Laminate - 820 mm depth	Ash F1004	828074
Laminate - 820 mm depth	Light gray F7927	828014
Laminate - 820 mm depth	Gray F7912	828004
Laminate - 820 mm depth	Anthracite F2297	828034
Laminate - 820 mm depth	Black F2253	828024

Note that the color reproduction in the catalog may differ from physical products.

Worktops MFC laminate*



White
(U6458)



Light gray
(U12188)



Anthracite
(U12011)

*Airtec-lipping

Name	Color	Art no
Worktop - 390 mm depth	White U6458	829003
Worktop - 390 mm depth	Light gray U12188	829103
Worktop - 390 mm depth	Anthracite U12011	829203
Worktop - 600 mm depth	White U6458	829001
Worktop - 600 mm depth	Light gray U12188	829101
Worktop - 600 mm depth	Anthracite U12011	829201
Worktop - 760 mm depth	White U6458	829002
Worktop - 760 mm depth	Light gray U12188	829102
Worktop - 760 mm depth	Anthracite U12011	829202
Worktop - 820 mm depth	White U6458	829004
Worktop - 820 mm depth	Light gray U12188	829104
Worktop - 820 mm depth	Anthracite U12011	829204

Worktops Veneer

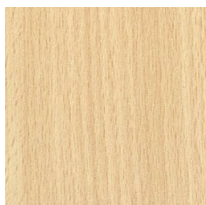

Beech Veneer

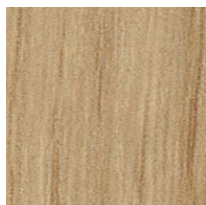

Oak Veneer



Birch Veneer

Name	Color	Art no
Veneer - 390 mm depth	Beech	823003
Veneer - 390 mm depth	Birch	825003
Veneer - 390 mm depth	Oak	827003
Veneer - 600 mm depth	Beech	823001
Veneer - 600 mm depth	Birch	825001
Veneer - 600 mm depth	Oak	827011
Veneer - 760 mm depth	Beech	823002
Veneer - 760 mm depth	Birch	825002
Veneer - 760 mm depth	Oak	827012
Veneer - 820 mm depth	Beech	823004
Veneer - 820 mm depth	Birch	825004
Veneer - 820 mm depth	Oak	827014

Worktops Rounded corners

Please note preferred radius of all corners when ordering.

Name	Radius	Art no
Rounded corners	Min. radius 100 mm	820010

High pressure laminate: 23 mm standard work-tops with high pressure laminate and 2 mm matching airtec-lipping*.

- Formica Collection Colors
- Formica Collection Woods

MFC laminate: 22 mm standard worktops have an outer paper layer coated with an impregnated paper and a finish of aluminum particles for extra protection against wear. 2 mm matching airtec-lipping*.

Veneer: 22 mm clear lacquered beech, birch or oak veneered chipboard with 2 mm solid lipping.

Airtec-lipping: Airtec-lipping, also known as laser edging, provides an almost invisible joint between the worktop and edging strip. Thus provides a higher protection against water and heat. This new technology is glue-free, which results in a lower environmental impact.

Inserts: Powder-coated steel insert, available in white or black.

- Round with diameter 110, 250 or 400 mm.
- Square 250x250 mm or 350x350 mm.
- Slim 340x40 mm.

Lid for insert: Powder-coated steel. Available for round inserts with diameters 250 and 400 mm.

Inserts: Stainless steel, integrated ring in worktop

- Round 250 mm in diameter.

Lid for insert: Compact laminate, folded in / integrated into ring, thickness 6 mm

- Round 250 mm in diameter with knob.
- Compact laminate, Formica F2297 (anthracite) alt. F1040 (white).

Inserts and lids, see page 100.

Contact TreCe if you want worktops in other high-pressure materials or other materials such as Valchromat.

CombiLine

Inlets



250x250

350x350

Ø 250

Ø 110

Ø 400

340x40



Inlet with powder-coated frame, 250x250 mm.



Inlet with powder-coated frame, 250x250 mm.



Lid with knob for round inlets in lacquered steel.



Inlet and lid integrated/lowered in worktop.



Lid in compact laminate, (F2297).

Inlet with powder-coated steel frame

Name	Size	Color	Art no
Inlet round	Ø 110	White	820951
Inlet round	Ø 250	White	820953
Inlet round*	Ø 400	White	820955
Inlet round	Ø 110	Black	820952
Inlet round	Ø 250	Black	820954
Inlet round*	Ø 400	Black	820956
Inlet slim	340x40	White	820966
Inlet slim	340x40	Black	820967
Inlet square	250x250	White	820961
Inlet square*	350x350	White	820963
Inlet square	250x250	Black	820962
Inlet square*	350x350	Black	820964

* Only fits cabinets with depth 725–790 mm.

Lid with knob for round inlets in lacquered steel

Name	Size	Color	Art no
Lid	Ø 250	White	820957
Lid*	Ø 400	White	820958
Lid	Ø 250	Black	820959
Lid*	Ø 400	Black	820960

Inlet and lid integrated/lowered in worktop

Name	Size	Material	Art no
Inlet round	Ø 250	Stainless	820980
Lid inlet compact laminate	Ø 250	White (F1040)	820985
Lid inlet compact laminate	Ø 250	Anthracite (F2297)	820986

Lid with stainless knob, Ø 19 mm.

NCS refers to product lacquered in any optional NCS color.

CombiLine

Accessories

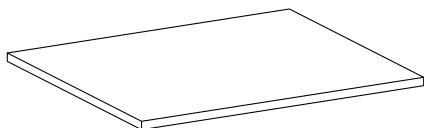

Shelves, Depth 370 mm (Width x Depth)

Name	White	NCS	Beech	Birch	Oak
30/370	841916	849916L	843916	845916	847916
60/370	831921	839921L	833921	835921	837921
80/370	831923	839923L	833923	835923	837923
90/370	831922	839922L	833922	835922	837922

Shelves, Depth 570 mm (Width x Depth)

Name	White	NCS	Beech	Birch	Oak
30/570	821913	829913L	823913	825913	827913
60/570	821914	829914L	823914	825914	827914
80/570	821916	829916L	823916	825916	827916
90/570	821915	829915L	823915	825915	827915

Tempered Glass shelf, Depth 370 mm, 6 mm (Width x Depth)

Name	Art no
60/370	840941
80/370	840942
90/370	840943

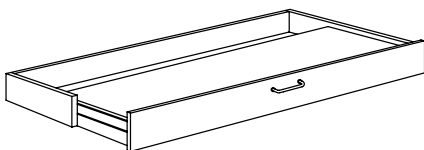

Pull-out shelf, wall

Name	White	NCS	Beech	Birch	Oak
U2 60	811911	819911L	813911	815911	817911
U3 90	811912	819912L	813912	815912	817912

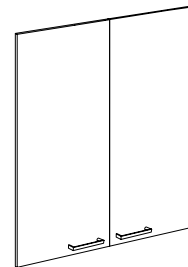

Wooden doors Width/number of shelves

Name	White	NCS	Beech	Birch	Oak
30/1 (one)	841918	849918L	843918	845918	841918
30/2 (one)	831972	839972L	833972	835972	837972
30/3 (one)	831973	839973L	833973	835973	837973
30/4 (one)	831974	839974L	833974	835974	837974
30/5 (one)	831975	839975L	833975	835975	837975
60/1 (pair)	831940	839940L	833940	835940	837940
60/2 (pair)	831941	839941L	833941	835941	837941
60/3 (pair)	831942	839942L	833942	835942	837942
60/4 (pair)	831947	839947L	833947	835947	837947
60/5 (pair)	831943	839943L	833943	835943	837943
80/1 (pair)	831983	839983L	833983	835983	837983
80/2 (pair)	831949	839949L	833949	835949	837949
80/3 (pair)	831987	839987L	833987	835987	837987
80/4 (pair)	831992	839992L	833992	835992	837992
80/5 (pair)	831993	839993L	833993	835993	837993
90/2 (pair)	831944	839944L	833944	835944	837944
90/3 (pair)	831945	839945L	833945	835945	837945

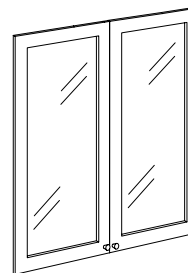

Glass doors Width/number of shelves

Name	White	NCS	Beech	Birch	Oak
30/2 (one)	831957	839957L	833957	835957	837957
60/2 (pair)	831951	839951L	833951	835951	837951
60/3 (pair)	831952	839952L	833952	835952	837952
60/4 (pair)	831958	839958L	833958	835958	837958
60/5 (pair)	831953	839953L	833953	835953	837953
80/2 (pair)	831960	839960L	833960	835960	837960
80/3 (pair)	831995	839995L	833995	835995	837995
80/4 (pair)	831996	839996L	833996	835996	837996
80/5 (pair)	831997	839997L	833997	835997	837997
90/2 (pair)	831954	839954L	833954	835954	837954

If you would like tempered glass, contact TreCe

NCS refers to product lacquered in one optional NCS color.

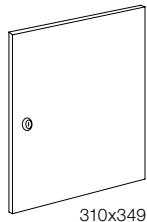

310x349

Door (Fits Combi shelf)

Name	White	NCS	Beech	Birch	Oak
Door incl. lock	841915	849915L	843915	845915	847915
Door incl. handle	841918	849918L	843918	845918	847918
Door incl. knob	841917	849917L	843917	845917	847917

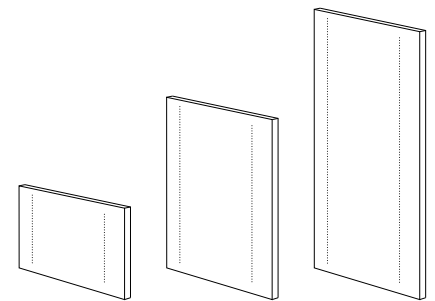

Partition panel, fits width 605, 800 and 900 mm

Name	White	NCS	Beech	Birch	Oak
Partition panel 371	811913	819913L	813913	815913	817913
Partition panel 723	801912	809912L	803912	805912	807912
Partition panel 1075	801915	809915L	803915	805915	807915

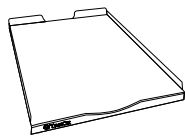

Mail shelves (Incl. mounting fitting)

Name	White	NCS	Beech	Birch	Oak
Mail shelf, acrylic		Transparent	267 mm	810919	
Mail shelf, steel		White	267 mm	810927	
Mail shelf, steel		Black	267 mm	810918	

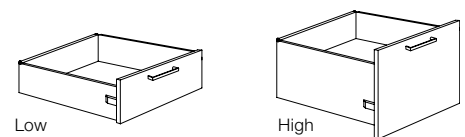

Low

High

Drawer low, 70% expansion, depth 570 mm (Max 30 kg/drawer)

Name	White	NCS	Beech	Birch	Oak
Low 30/570	831702	839702L	833702	835702	837702
Low 60/570	831703	839703L	833703	835703	837703
Low 80/570	831705	839705L	833705	835705	837705

Drawer high, 70% expansion, depth 570 mm (Max 30 kg/drawer)

Name	White	NCS	Beech	Birch	Oak
High 60/570	831704	839704L	833704	835704	837704
High 80/570	831709	839709L	833709	835709	837709

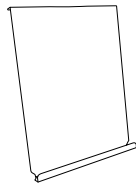

Expo shelf (Incl. mounting fitting)

Name	Art no
Expo shelf, white, powder-coated steel	840928
Expo shelf, black, powder-coated steel	840929

Drawer low, 100% expansion, depth 570 mm (Max 35 kg/drawer)

Name	White	NCS	Beech	Birch	Oak
Low 30/570	831720	839720L	833720	835720	837720
Low 60/570	831721	839721L	833721	835721	837721
Low 80/570	831722	839722L	833722	835722	837722

Pull-out shelf, Wall

Name	White	NCS	Beech	Birch	Oak
U2 60	811911	819911L	813911	815911	817911
U3 90	811912	819912L	813912	815912	817912

Drawer high, 100% expansion, depth 570 mm (Max 50 kg/drawer)

Name	White	NCS	Beech	Birch	Oak
High 60/570	831714	839714L	833714	835714	837714
High 80/570	831719	839719L	833719	835719	837719

NCS refers to product lacquered in one optional NCS color.

Cabinet locks (incl. 2 keys)

Name	Art no
Cabinet locks, different lock numbers	830910
Addition, identical locks	830985

If you would like other lock types, see page 61.

Master key

Name	Lock type	Art no
Master key	Cabinet locks	840913

Stuff, Vide and bag holder

Name	Size	Art no
Stuff cork box	90x44x347	890101
Stuff shelf cork box	97x80x350	890201
Vide, box	298x300x345	223001
Vide, box with divider	298x300x345	223002
Bag holder, mobile	Ø 35 mm	830880



Grip handles Edge, addition



Handles, standard

Grip handles Edge

Name	Size	Material	Art no
Grip handles Edge	40 mm	Stainless steel look	850322
Grip handles Edge	40 mm	Black, brushed	850320
Grip handles Edge	40 mm	White, lacquered	850321

Handles, standard

Name	Size	Stainless	Black	White
Handles*	c/c 128 mm	850304	850302	850303

* Stainless steel handles as standard, if you would like black or white please specify when ordering. If you would like other handles please contact TreCe.

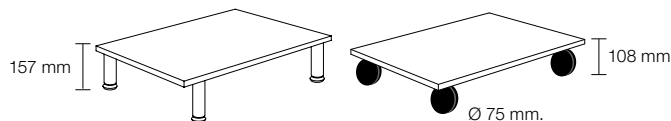

Stainless adjustable legs. If you would like other legs/wheels contact TreCe.

Load capacity per wheel: 100 kg
Material: black, rubber surface.
2 wheels have brakes.

Leg set, Height 157 mm, Depth 370 mm (Incl. base plate)

Name	White	NCS	Beech	Birch	Oak
30/370	841936	879936L	843936	845936	847936
60/370	841937	879937L	843937	845937	847937
80/370	841940	879940L	843940	845940	847940

Leg set, Height 157 mm, Depth 570 mm (Incl. base plate)

Name	White	NCS	Beech	Birch	Oak
30/570	841931	879931L	843931	845931	847931
60/570	841932	879932L	843932	845932	847932
80/570	841939	879939L	843939	845939	847939
90/570	841933	879933L	843933	845933	847933

Wheel set, Height 108 mm, Depth 570 mm (Incl. base plate)

Name	White	NCS	Beech	Birch	Oak
30/570	841921	879921L	843921	845921	847921
60/570	841922	879922L	843922	845922	847922
80/570	841926	879926L	843926	845926	847926
90/570	841923	879923L	843923	845923	847923

If you would like other wheels, contact TreCe.



Knobs, standard

Name	Size	Stainless	Black	White
Knobs*	ø 19 mm	850313	850312	850314

* Stainless knobs as standard, if you would like black or white please specify when ordering. If you would like other handles please contact TreCe.

Dimensions: Width x Height x Depth.

Place

Shelf

Place is available in two shelf widths (361 and 739 mm, excluding end gables) and three different heights (1003, 1433 and 1863 mm) that can be easily assembled and adapted as needed.

As a step in TreCe's continuous environmental work, Place is delivered in flat packages and can be mounted easily on site.

The gables are pre-assembled and the shelves mounted with cam lock screws from above.

The decor shelf, which is put in place after the supporting shelf is mounted, conceals the fittings and gives a neat finish.

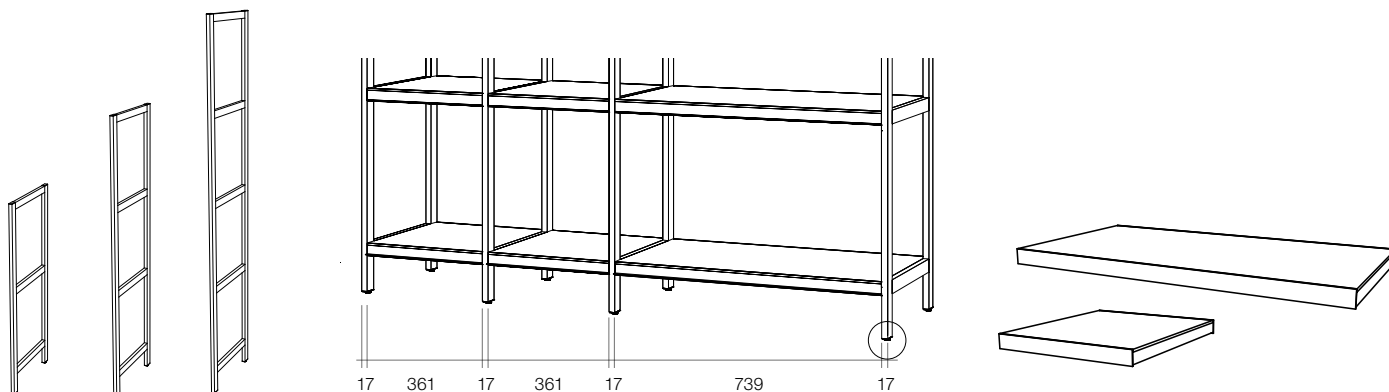

Outer gables, thickness 17 mm

Name	Size (WxH)	Color	Art no
Place Outer gable 1003	395x1003	RAL 7016	401111
Place Outer gable 1433	395x1433	RAL 7016	401112
Place Outer gable 1863	395x1863	RAL 7016	401113

Middle gables, thickness 17 mm

Name	Size (WxH)	Color	Art no
Place Middle gable 1003	395x1003	RAL 7016	401121
Place Middle gable 1433	395x1433	RAL 7016	401122
Place Middle gable 1863	395x1863	RAL 7016	401123

Converter gables, thickness 17 mm

Name	Size (WxH)	Color	Art no
Place Converter 1433-1003	395x1433	RAL 7016	401131
Place Converter 1863-1003	395x1863	RAL 7016	401132
Place Converter 1863-1433	395x1863	RAL 7016	401133

Supporting shelf, thickness 35 mm

Name	Size	Color	Art no
Place Supporting shelf 361	361x35x395	Ash	402111
Place Supporting shelf 739	739x35x395	Ash	402121

Supporting shelves in anthracite laminate 35 mm including decor shelf light ash



Wall-mounted storage

Build your own wall-mounted storage from shelves, rails and brackets.



Bracket shelf

Name	Depth	White	Beech	Birch	Oak
Laminate					
Shelf	300	911300	912300	914300	916300
Shelf	400	911400	912400	914400	916400
Shelf	500	911500	912500	914500	916500
Shelf	600	911600	912600	914600	916600
Laminate					
Shelf	300		913300	915300	917300
Shelf	400		913400	915400	917400
Shelf	500		913500	915500	917500
Shelf	600		913600	915600	917600

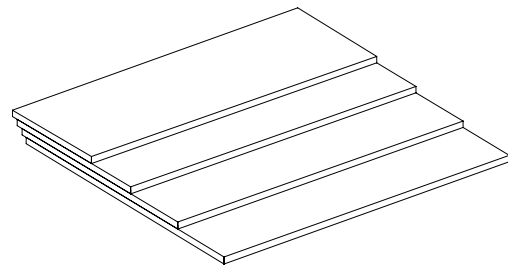

The maximum length of our shelves are 2400 mm without a joint. Remember to include mounting brackets when dividing a shelf.

Accessories

Name	Length	Art no
Wall upright white	390	550101
	683	550102
	1009	550103
	1204	550104
	1595	550105
	1986	550106
Wall upright to suspension rail, white	1010	550111
	1237	550112
	1501	550113
	1951	550114
Suspension rail	950	550121
	1220	550122
	1900	550123
Joint strip	500	550145
Bracket, white	270	550131
	370	550132
	470	550133
Bracket reinforced	570	550136
Mounting bracket, 6-pcs/package		550141
Bracket screw for 10 brackets	270–370	550143
Bracket screw for 10 brackets	470–670	550144

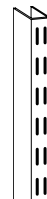

Wall upright



Wall upright to suspension rail

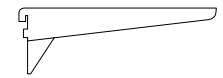

Bracket reinforced

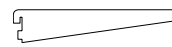

Bracket

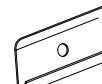

Suspension rail

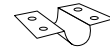

Mounting bracket

Angle bracket, white

Name	Fits	Size (HxD)	Art no
Bracket reinforced with support	Depth 400–500	270	550134
Bracket reinforced with support	Depth 500–600	370	550135

Dimensions: Width x Height x Depth

Drawing cabinet

White laminated frame with white lacquered fronts with stainless steel handles. Drawers have rails with integrated hubs that make them easy to handle which makes the storage more functional and versatile.

If you would rather like black or white handles, please make a note on your order. Plinth/base, frame and top in white laminate. Drawer fronts in white lacquer NCS S 0500-N.



Drawing cabinet, 5 drawers and top (Width x Height x Depth)

Name	Size	White
A1 top cabinet	991x366x684	411101
A1 under cabinet	991x366x684	411201
A1/A0 top cabinet	1345x366x684	411103
A1/A0 under cabinet	1345x366x684	411203
A0 top cabinet	1345x366x950	411102
A0 under cabinet	1345x366x950	411202

Plinth

Name	Size	White
Plinth A1	Height 80	440201
Plinth A1/A0	Height 80	440203
Plinth A0	Height 80	440202

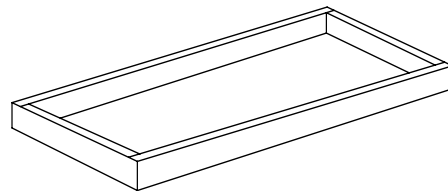

Leg set

Name	Size	White
Leg set	Height 446	431101

Legs in white lacquered steel, fit all models.

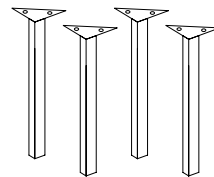

Dimensions: Width x Height x Depth

Archive shelf

Pine

Archive shelf in lacquered massive pine. Stable design that is easy to move and adjust.

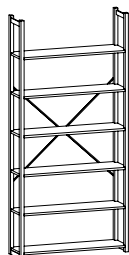
Complete shelf /start section incl:

- 2 Open gables
- Shelves
- Cross brace
- Support bracket excl. top shelf.

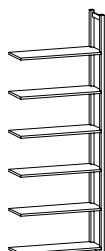
Add-on-section incl:

- 1 Open gables
 - Shelves
 - Support bracket excl. top shelf.
- Add cross brace, if needed.



Complete shelf /start section

Add-on-section

Complete shelf/start section
Add-on sections

Size/Number of shelves	Art no	Size/Number of shelves	Art no
830x1830x300/5	251030	800x1830x300/5	252030
830x1830x400/5	251040	800x1830x400/5	252040
830x1830x500/4	251050	800x1830x500/4	252050
830x1830x600/4	251060	800x1830x600/4	252060
830x2180x300/6	251330	800x2180x300/6	252330
830x2180x400/6	251340	800x2180x400/6	252340
830x2180x500/5	251350	800x2180x500/5	252350
830x2180x600/5	251360	800x2180x600/5	252360
1030x1830x300/5	251130	1000x1830x300/5	252130
1030x1830x400/5	251140	1000x1830x400/5	252140
1030x1830x500/4	251150	1000x1830x500/4	252150
1030x1830x600/4	251160	1000x1830x600/4	252160
1030x2180x300/6	251430	1000x2180x300/6	252430
1030x2180x400/6	251440	1000x2180x400/6	252440
1030x2180x500/5	251450	1000x2180x500/5	252450
1030x2180x600/5	251460	1000x2180x600/5	252460
1230x1830x300/5	251230	1200x1830x300/5	252230
1230x1830x400/5	251240	1200x1830x400/5	252240
1230x1830x500/4	251250	1200x1830x500/4	252250
1230x1830x600/4	251260	1200x1830x600/4	252260
1230x2180x300/6	251530	1200x2180x300/6	252530
1230x2180x400/6	251540	1200x2180x400/6	252540
1230x2180x500/5	251550	1200x2180x500/5	252550
1230x2180x600/5	251560	1200x2180x600/5	252560

Shelves (Width x Depth) Max 100 kg/shelf

Name	Size	Art no
Shelves pine	800x300	608030
Shelves pine	800x400	608040
Shelves pine	800x500	608050
Shelves pine	800x600	608060
Shelves pine	1000x300	610030
Shelves pine	1000x400	610040
Shelves pine	1000x500	610050
Shelves pine	1000x600	610060
Shelves pine	1200x300	612030
Shelves pine	1200x400	612040
Shelves pine	1200x500	612050
Shelves pine	1200x600	612060

Open gables (Height x Depth)

Name	Size	Art no
Open gables	1830x300	618330
Open gables	1830x400	618340
Open gables	1830x500	618350
Open gables	1830x600	618360
Open gables	2180x300	621830
Open gables	2180x400	621840
Open gables	2180x500	621850
Open gables	2180x600	621860
Open gables	2480x300	624830
Open gables	2480x400	624840
Open gables	2480x500	624850
Open gables	2480x600	624860

Parts/accessories (Width x Height)

Name	Size	Art no
Back white	1000x1830	653181
Back white	800x1830	653188
Back white	1000x2180	653211
Back white	800x2180	653218
Cross brace 100		690100
Cross brace 120		690120

Name	Art no
Mounting Bracket*	690150
Wall mount	690160
Support bracket, wire 30**	690300
Support bracket, wire 40**	690400
Support bracket, wire 50 reinforced**	690501
Support bracket, wire 60 reinforced**	690601

*2 mounting brackets per gable pair.
**2 support bracket wires per shelf.

Dimensions: Width x Height x Depth

Archive

Steel/Pine

Robust archive for efficient storage of large volumes. Compact, robust and easy-working. Gables and shelves in steel can handle high loads, 50–120 kg per shelf at widened load. If necessary, the archive can be customized for even greater weight. Choose between steering wheel, power steering or handle.



Compact Archive with steering lock and back panels for added security.

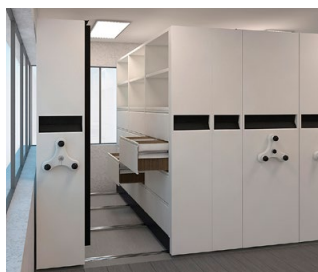

Steering wheel-driven compact archive with pull-out filing for different folder sizes.



A flexible compact archive in lacquered steel sheet that can be customized to the different formats archived, ex A4 or standing A4.

The height, width or length can be adjusted and designed as needed.



Complete archive for efficient storage of large volumes. Compact, robust and easy to work.

Gables and shelves in lacquered solid pine.

Archives withstand very high loads – 100 kg per shelf. If necessary, the archive can be adapted to hold greater loads.

Choose between the wheel operation or handles.

Contact us for more information
ph +46 11-21 14 80, sales@trece.se
or www.trece.se.

Specifications

Space

Space

MFC laminated surfaces within Space have a chip core, with the exception of some shelves.

Back, frame and edging strip have matching colors unless otherwise stated.

Fronts, Shoe shelf, Open shelf/Bench and Storage box open/Flower box have an MDF core. Textiles at an additional cost.

Frame incl. plinth

Thickness 16 mm, 0.8 mm straight ABS-lipping.

- MFC laminate, white.
- Lacquered, any NCS-color.

Back

Thickness 16 mm, MFC laminate in- and out.

Lacquered when choosing any NCS-color.

Plinth

Each unit has its own setback plinth, front and rear, with 4 adjustable feet, (Plinth 143 mm.)

Fronts

Seamless fronts, thickness 16 mm

- Lacquered MDF, any NCS color.

Drawers

Drawers have soft closing. Extension capacity of 100%, maximum weight 35 kg.

- Drawers with railings or with elevated sides.

Seat module with hatch door

Opens downwards with gas spring.

- Milled-in handle

Shoe shelf, Open shelf/Bench and Storage box open/Flower box

Thickness 16 mm.

- Lacquered MDF, any NCS color.
- Modules aligned with fronts.

Double doors Wardrobes

With milled-in handles.

Mail inlet

Powder-coated steel, White (RAL 9010). Opening 290x20 mm. Mail inlet has an angled steel lip on the inside of the door.

Hinges

- Self closing concealed hinges with integrated soft closing.
- Doors are right-hung as standard.

Shelves, fixed

Shelves mounted with milled-in connection fittings that are secured with screws.

- Shelves for lockers have a chip core
- Shelves for wardrobes have a lamellar wood core.

Shelves, movable

Shelves are shortend in the front. Mounted with connection fittings, adjustable by drill division of c/c 32 mm.

Cover panels/Top cover panels

Thickness 16 mm.

- Lacquered MDF, any NCS color.

Top cover, socket strip:

Thickness 28 mm

- Lacquered MDF, any NCS color.

Accessories

Clothes rail, carpet, clothes hook, anchor hook, mirror and cork box Stuff.

Lock types

Cabinets locks, padlock fittings, code locks, RFID-locks (EM & Mifare) and push-to-open.

General info

Mounting

All modules are factory mounted.

Worktops/Cover panels/Top cover panels are mounted on site.

Warranty

We provide a 5 year factory warranty on Space. Other products, contact TreCe.

Cabinet locks

Robust cabinet locks with master key system, individual numbers with 2 keys as standard. Identical locks available to addition.

Contact TreCe for customization of selected product.

Specifications

CombiLine

CombiLine

MFC laminated and lacquered surfaces within CombiLine have a chip core, with the exception of some shelves. Back, frame, doors and edge strips have the same color/wood as other parts as standard, unless otherwise stated.

Frame

Thickness 19 mm, 0.8 mm straight ABS-lipping.

- MFC laminate white, beech, birch and oak.
- Lacquered available in any NCS-color.

Back

Thickness 12 mm, laminate inside and outside.

Plinth

Every module has its own front and back plinth with 4 adjustable feet (does not apply to recycling units with loading ramps). Plinth 157 mm. Can be replaced with;

- Bottom plate with adjustable stainless steel legs, height 157 mm.
- Bottom plate with lockable wheels, height 104 mm.

Doors

Thickness 16 mm, 2 mm straight ABS-lipping.

- White lacquered UV-treated MFC laminate (NCS S 0500-N), or MFC laminate in beech/birch/oak.
- Lacquered in any NCS color.
- Self closing concealed hinges with integrated soft closing (does not apply to products with aximat hinges with 180° opening).
- Single doors are right-hung as standard.

Drawer fronts

Thickness 16 mm, 2 mm straight ABS-lipping.

- White lacquered UV treated MFC laminate (NCS 0500-N) and MFC laminate in beech/birch/ oak.
- Lacquered available in any NCS-color.

Drawers

Drawers with depth 570 mm have soft closing.

- Extension 70%, max 30 kg.
- Extension 100%, max 35 kg (excl. recycling units).
- Extension 100%, max 50 kg.

Shelves

All shelves are adjustable and mounted with milled-in shelf support. Drill division c/c 32 mm.

- 310 – 605 mm have a chip core.
- 800 – 900 mm have a pine lamellar core.

Recycling unit

MDL60/MD60/MDH60/MD65/MD70

The bottom plate is equipped with an access ramp in stainless steel.

- Doors with aximat hinges for 180 degree opening for easy access to recycling containers.

Mail shelves

Adjustable with pull-out function and mounting strip, subdivision c/c 96 mm.

- Mail shelves in acrylic have integrated name slots.
- Mail shelves in powder coated steel white or black are available as an addition.

Steel doors mail sorting

White powder coated steel. Shelves inside in the same material as frame, 19 mm.

- Including lock and 2 keys with individual lock number.
- Inlet 22 mm. Open door gives a free space of 90 mm.

Wall modules

White lacquered mounting strip in steel is included for all wall modules.

Lock types

Cabinets locks, padlock fittings, code locks and RFID-locks (EM & Mifare).

Fitting pieces /Cover panels

Available as accessories in the same color/material as frame. Width, height and depth adapted to your requirements.

Handles

Stainless steel bow handles as standard, if you would like black or white handles, please not on order.

- Standard handles c/c 128 mm.
- Grip handles 40 mm.

General info

Mounting

All modules are factory mounted. Worktops/Cover panels/Top covers are mounted on site.

Warranty

We provide a 5 year factory warranty on CombiLine. Other products, contact TreCe.

Cabinet locks

Robust cabinet locks with master key system, individual numbers with 2 keys as standard. Identical locks available to addition.

Contact TreCe for customization of selected product.



Norrköping – Sweden / Head office / Showroom

Importgatan 39
P.O. Box 6063, SE-600 06 Norrköping
Ph +46 11 21 14 80
info@trece.se
www.trece.se

Stockholm – Sweden / Showroom

R40 Center
Rosenlundsgatan 40
Ph +46 8 48 00 27 50

Oslo – Norway / Showroom

Studio Thune
Drammensveien 130 B13, Skøyen
Ph +47 23 96 07 22